

# Application to DHCD Submitted through CAMS

Augusta County

Augusta County VATI 2019 Middlebrook

---

**Application ID:** 59810042018110041  
**Application Status:** In Progress - DHCD  
**Program Name:** Virginia Telecommunications Initiative 2019  
**Organization Name:** Augusta County  
**Organization Address:** 18 Government Center Lane  
Verona, VA 24482  
**Profile Manager Name:** Jennifer Whetzel  
**Profile Manager Phone:** (540) 245-5610  
**Profile Manager Email:** jwhetzel@co.augusta.va.us

**Project Name:** Augusta County VATI 2019 Middlebrook  
**Project Contact Name:** Jennifer Whetzel  
**Project Contact Phone:** (540) 245-5610  
**Project Contact Email:** jwhetzel@co.augusta.va.us  
**Project Location:** 18 Government Center Lane  
Verona, VA 24482-0590  
**Project Service Area:** Augusta County

**Total Requested Amount:** \$243,197.00  
**Required Annual Audit Status:** Accepted

# Application to DHCD Submitted through CAMS

Augusta County

Augusta County VATI 2019 Middlebrook

---

## Budget Information:

Cost/Activity Category	DHCD Request	Other Funding	Total
<b>Telecommunications</b>	<b>\$243,197.00</b>	<b>\$104,277.50</b>	<b>\$347,474.50</b>
Construction	\$243,197.00	\$104,277.50	\$347,474.50
<b>Total:</b>	<b>\$243,197.00</b>	<b>\$104,277.50</b>	<b>\$347,474.50</b>

Budget Narrative:

Construction budget consists of fiber placement, fiber-to-the-home, middle mile build out and site preparation costs. Local match is at 30% of the project and 70% of the project costs are requested from the VATI Grant.

## Questions and Responses:

### 1. Project Area

Provide a map and description of the proposed geographic area including specific boundaries of the project area e.g.; street names, local and regional boundaries, etc. Explain why and how the project area(s) was selected. Attach a copy of your map(s).

#### Answer:

The proposed project includes the placement of 5.3 miles of middle-mile fiber and at least 1.7 miles of last-mile fiber (service drops) that will provide broadband access to the residents, businesses, and community anchor institutions along a significant stretch of Middlebrook Road. Middlebrook Road is a state primary road (Rt. 252), a main travel corridor in the central area of southern Augusta County, and is the gateway to the Village of Middlebrook and several other rural areas of the County. The proposed project in an in area that is classified as having “no or dissatisfied internet connection” according to the County’s Broadband Telecommunications Strategic Plan. In addition, this project area builds upon a recently completed middle-mile project that was implemented through a Public-Private Partnership. Similarly, the proposed project was also designed with consideration of the next phase of middle-mile, including future spurs/laterals off Middlebrook Road, and to make broadband available to many more locations than could be installed during the 1-year VATI contract period.

Census Blocks are the geographic unit for which ISP’s report their deployment data to the FCC using the required Form 477. Aside from local knowledge of the existing telecommunications infrastructure in the County and results from our outreach efforts, the Form 477 data is a dataset commonly used to determine the location & internet speeds that internet service providers are providing in a specific Census Block. Therefore, this project area was defined using Census Block boundaries to ensure that the project area was eligible for VATI funding and did not overlap with any CAF funded areas. A Project Area Map is included with this application and depicts the project area along with the proposed infrastructure included in the scope of this project. The proposed project area meets the definition of unserved and is eligible for VATI funding. The 8 Census Blocks included in the project area are listed below:

# Application to DHCD Submitted through CAMS

Augusta County

Augusta County VATI 2019 Middlebrook

---

- 510150709001059
- 510150709001068
- 510150709001090
- 510150710001047
- 510150710001048
- 510150710001050
- 510150710001051
- 510150710001076

see attachment:

*4\_ProjectAreaMap*

2.

Describe your outreach efforts to identify existing providers in the selected project area. Provide a map and list of all existing providers (fixed and wireless), and speeds offered within the project area. Provide a detailed explanation of how this information was compiled and the source(s).

**Answer:**

Augusta County has been planning for and pursuing funding opportunities for broadband implementation projects for several years and completed a Broadband Telecommunications Strategic Plan in late-2016. Within the last year, the County formalized a Broadband Committee to spear-head broadband expansion projects and community education and outreach. In addition to the community surveys performed during the development of the broadband plan, a significant outreach effort was made specific to this application to the 2019 VATI program. The information collected during the outreach efforts confirmed that the citizens and business in this area have struggled with inadequate connectivity for far too long and this is one of the more unserved areas of the County. Unlike fixed wireless, a fiber internet project provides broadband availability to every location it passes- not just those that might have line-of-sight to a tower or antenna many miles away. In addition, the bandwidth required by the locations (and not just the businesses, home-based business, and ag-based businesses) in this area are well beyond what DSL or fixed wireless may provide. With the fiber internet service, anyone in the proposed project area would be able to get internet speed packages up to 1 Gbps. Here is a timeline for the most recent outreach efforts, including the required public comment period:

- Oct. 10, 2018 - County released RFP/RFI to identify an internet service provider (ISP) to partner with on a VATI application (emailed directly to 7 ISP's known to provide some internet service in the County)
- Oct. 30, 2018 - deadline for responses to the RFP/RFI (identified partnering ISP)
- Nov. 16, 2018 - released a notice for public comment (newspaper, website)
- Nov. 27, 2018 - mailed out 196 "internet survey" letters in the project area

# Application to DHCD Submitted through CAMS

Augusta County

Augusta County VATI 2019 Middlebrook

---

- Nov. 28, 2018 - Board meeting where comments on VATI application were heard

The County received 51 responses from the mail-out in the project area, and the results/comments speak for themselves. The responses generally fell into the following categories: (1) no internet available, (2) poor DSL service (very old copper plant in this area), (3) slow, unreliable satellite service, (4) fixed wireless service, or (5) limited mobile broadband through a cellular connection. Our partnering ISP, Lingo Networks, has a few customers in this area that are serviced with fixed wireless internet, but it is basically a “lifeline” service as the distance from their tower/antenna is too far to support the bandwidth needs. In addition, the County as well as the ISP have received phone calls from residents in the area reiterating the need for this project. Several also made comments about the lack of cellular coverage which rules out any options for mobile broadband. All the documentation for these numerous outreach efforts is included in an attachment.

These outreach efforts helped identify existing ISP’s in the project area. A map titled, “Middlebrook Outreach Effort”, is included in the attachment and presents 2 of the responses from a past survey- who their ISP is and if they are satisfied with their service. We also reviewed the most recent Form 477 data from the FCC as a dataset commonly used to identify unserved areas. After a detailed review of these outreach efforts and an analysis of the “boots of the ground” information, it was determined that while there may be 1-2 locations receiving internet speeds of 10/1 or greater- the project area is eligible for VATI funding. We understand that the 2019 VATI program allows for a 10% overlap and includes a challenge process, however, the due diligence has been done to define this area as unserved. Our local ISP’s which participate in the County’s broadband planning and implementation efforts, as well as, everyone living or working in the project area agree with this assessment and eagerly await reliable, high-speed internet.

see attachment:

*Opt1\_OutreachDocs*

### 3. Project Need/Description

To be eligible for VATI, applicants must demonstrate that the proposed project area(s) is unserved. An unserved area is defined as an area with speeds of 10 Mbps/1 Mbps or less, and with less than 10% service overlap within the project area. Describe the anticipated service overlap with current providers within the project area.

#### **Answer:**

According to our survey data and various outreach efforts, the proposed project area is unserved and eligible for VATI. During our analysis of the FCC’s Form 477 data, we were shocked to see that an ISP (Rural Broadband Network Service, LLC d.b.a. High Speed Link) recently reported having speeds of 12/3 available in almost the entire County. In Attachment #11 - Unserved, we’ve included (1) a table with the Form 477 for the 8 census blocks in the proposed project area, (2) a map of the County showing the census blocks reported by this provider as having 12/3 available, and (3) a map showing our survey and outreach data. This is the only provider in the 8 census block project area reporting any speeds over 10/1. If this was true, then broadband (>10/1 per VATI guidelines) would be available in 95% of the County- which it is not. In speaking with others in the industry about this potentially over-reported data, and knowing the locations & equipment utilized by this provider, we feel that in this case the Form 477 data should not be used to define whether the proposed project area is unserved. If this

# Application to DHCD Submitted through CAMS

Augusta County

Augusta County VATI 2019 Middlebrook

---

provider decides to utilize the challenge process set forth in the VATI guidelines, it would then be up to them to prove that they truly have the coverage represented by the Form 477 they have submitted to the FCC. In addition, fiber ensures that the state, local, and private funding is invested into a technology that can meet the bandwidth needs of the future. Based upon our local knowledge of the area, our survey results, and numerous outreach efforts- the Middlebrook Fiber Project meets the definition of unserved and is eligible for VATI.

see attachment:

*11\_Unserved*

4. Describe population both in terms of absolute numbers within the project area and the eligible users that will be served by the proposed project. Describe the basis for these projections.

**Answer:**

Demographic data provided by the Census Bureau is only available at the Census Block level during their decennial release. The 2010 population for the 8 Census Blocks included in the proposed project area is 201, and the number of housing units is 94. There are also approximately 141 locations with 911 addresses within 1,000' of the middle-mile fiber (Lingo will provide a free FTTH installation up to 1,000'). The eligible users in the proposed project area will be those locations that are within 250 ft of the middle-mile fiber. While the project passes approximately 141 locations, it would not be feasible to include the middle-mile fiber and all 141 FTTH installations in the scope of the project due to the 1-year contract limitations of the VATI program. While we will make every effort to connect as many as possible during the 1-year contract period, we have included 30 FTTH connections in the project budget. While the demand may be greater, this approach ensures that the project can be completed by the deadline of May 2020. Having the middle-mile in place will allow Lingo to more rapidly deploy additional FTTH connections after year-one.

5. Indicate the numbers of businesses and community anchor institutions the proposed project will pass in the project area.

**Answer:**

Due to the rurality of the proposed project area, there are few store fronts or community anchor institutions located directly along the path of the middle-mile fiber. The County has pulled business licenses and other information to assist in the identification of additional economic development assets to be included in the 2019 VATI application. In the Village of Middlebrook is a fire station, library, doctor's office, general store, and several other small or home-based businesses. The fire station requires adequate internet services in order to file records management report for revenue recovery billing. Based upon trends in the area and the scope of 30 FTTH connections, we have estimated that a minimum of 5 of the connections will be for business-class services.

see attachment:

*Opt2- CAI\_Business*

6. Provide the anticipated take rate for the proposed service within one year of project completion and describe the basis for the estimate. Also provide all actions to be implemented to reach the identified potential customers within the project area.

**Answer:**

Using past projects as a guide and recognizing that this is a very rural area of the County known for having few

# Application to DHCD Submitted through CAMS

Augusta County

Augusta County VATI 2019 Middlebrook

---

options for connectivity, we anticipate a take rate that is >70%. There are approximately 41 locations (eligible users) within 250 ft of the middle-mile fiber and it is anticipated that approximately 30 of those eligible users would request a FTTH connection.

As MGW/Lingo has done with past projects completed under a Public Private Partnership, an initial marketing/informative letter will be mailed to all prospective addresses in the project area. Depending on the return correspondence, door-hangers may also be used to inform the landowner or tenant of the opportunity to receive a FTTH connection. Once construction begins, it is common (especially in rural areas) for people in the area to stop and talk with the fiber crew to get in-person information about the project. In addition, there have been cases within past projects where the landowner or tenants desired to wait out an existing contract before entering into a new contract for service. MGW/Lingo has been flexible with potential clients in that regard while also meeting the deadlines of the VATI program.

7. A statement whether the proposed project is targeting the “last mile,” “middle mile,” or “backbone” portion of the broadband infrastructure.

**Answer:**

The proposed project was designed to facilitate last-mile, FTTH connections. However, considering that the middle-mile component of the scope of the project is 5.3 miles and the length of the last-mile service drops is approximately 1.7 miles, then from a linear and budget standpoint- the construction is primarily a middle-mile project.

8. For wireless projects only: Please explain the ownership of the proposed wireless infrastructure. Will the wireless co-applicant own or lease the radio mast, tower, or other raised structure onto which the wireless infrastructure will be installed?

**Answer:**

The proposed project does not include any wireless internet services or infrastructure.

9. Provide a description of the broadband service to be provided, including estimated download and upload speeds, whether that speed is based on dedicated or shared bandwidth, and the technology that will be used. This description can be illustrated by a map or schematic diagram, as appropriate.

**Answer:**

The broadband service in the proposed project is considered Fiber-to-the-Premise (FTTP) or Fiber-to-the-Home (FTTH). The proposed project is an extension off MGW/Lingo’s fiber network which is a carrier-class network that provides bandwidth to schools, hospitals, large and small resort facilities, and thousands of residential customers. There is an existing point-of-presence (POP) that will house the broadband distribution switch and other network electronics. The network is designed to be scalable to ensure it can serve future development and bandwidth needs. The actual download/upload speeds would be the speeds selected by the customer, and below is a list of the standard speed packages currently being offered by MGW/Lingo Networks:

SILVER25Mb Download x 5 Mbps Upload  
GOLD50Mb Download x 10 Mbps Upload  
PLATINUM100Mb Download x 20 Mbps Upload  
PLATINUM ELITE200Mb Download x 40 Mbps Upload  
\*Custom packages are available with speeds up to 1 Gbps

# Application to DHCD Submitted through CAMS

Augusta County

Augusta County VATI 2019 Middlebrook

---

see attachment: *#Opt3 - Network Diagrams*

10. Provide a description of the network system design used to deliver broadband service from the network's primary Internet point(s) of presence to end users, including the network components that already exist and the ones that would be added by the proposed project. Also describe specific advantages of using this technology. Provide a detailed explanation on how this information was compiled and source(s). For wireless projects, provide a propagation map including the proposed project.

**Answer:**

Lingo Networks shall deploy a FTTP network architecture which allows for the delivery of voice and data services across the broadband access platform. MGW/Lingo will utilize redundant Ethernet uplinks from the proposed FTTP electronics to its existing softswitch to facilitate voice services. The fiber optic cable infrastructure will be designed in a manner that permits MGW/Lingo to utilize various technologies such as Active Ethernet, Gigabit Passive Optical Network (GPON), or various other next-generation technologies. Redundant connections ensure highly reliable broadband data communications services and MGW/Lingo will utilize its existing and new data network routers, Internet uplinks, and ISP services as needed. MGW/Lingo has a point-of-presence (POP) less than 500 ft away from proposed project area which will house the FTTP electronics and be the hub for the fiber network designed to serve the proposed project area.

The POP was constructed with growth in mind, so few new FTTP electronics will be needed for the proposed project. Therefore, the project budget includes mostly materials and labor used in the construction of the outside plant (OSP) and includes fiber pedestals and enclosures, splicing trays, an ONT or other DMARC at the customers location, and a router or other Customer Premise Equipment (CPE) as needed or requested.

see attachment: *#Opt3 - Network Diagrams*

11. Project Readiness

What is the current state of project development (i.e. planning, preliminary engineering, final design, etc.)? Prepare a detailed project timeline or construction schedule, which identifies specific tasks, staff, contractor responsible(s), collection of data, etc., and estimated start and completion dates. The timeline should include all activities being completed within 12 months of contract execution with DHCD.

**Answer:**

The current state of project development could be considered beyond the planning phase and well into the engineering phase. MGW is a telecom utility and performs the majority of their engineering, permitting, and landowner negotiations in-house, as well as, main cable and drop cable construction. Upon the Governor's announcement of an award, we would immediately send out letters to the addresses in the project area informing them of the project and to sign-up for a free FTTH installation. At the same time, Land Use Permit (LUP) applications will be submitted to VDOT for the middle-mile portion of the project. MGW/Lingo has been selected through competitive procurement processes for broadband projects in the past, including projects that were administered through a Public Private Partnership. Minimal work would be required prior to the start of construction, therefore this project is considered to be shovel-ready.

12. Matching funds: Provide a description of the matching funds the applicant and co-applicant will invest in the proposed project, (VATI funding cannot exceed 80% of total project cost). The Funding Sources Table should be completed.

# Application to DHCD Submitted through CAMS

Augusta County

Augusta County VATI 2019 Middlebrook

---

- i. For each element of matching funds in the description, indicate the type of match (cash, salary expense, or in-kind contribution).
- ii. Identify whether the applicant or co-applicant is responsible for providing each element of the proposed matching funds.
- iii. Include copies of vendor quotes or documented cost estimates supporting the proposed budget.

**Answer:**

The County and its partnering ISP are proposing to provide a combined match of 30%, greater than the 20% required by the VATI program. The entirety of this 30% match shall be in cash and documentation of this financial commitment from both the County and the ISP are included with this application.

see attachment:

*#10 - Match Commitment*

see attachment:

*#13 - Funding Sources Table*

13. Identify key individuals, including name and title, who will be responsible for the management of the project. Describe their role and responsibilities for the project. Present this information in table format.

**Answer:**

A table has been prepared with information on key personnel assigned to the project and has been uploaded as an attachment.

see attachment:

*#Opt4 - Key Personnel*

14. Applicant and Co-Applicant: A description of the public-private partnership involved in the project. Detail the local government assistance: Local government co-applicants should demonstrate assistance to project that will lower overall cost and further assist in the timely completion of construction, including assistance with permits, rights of way, easement and other issues that may hinder or delay timely construction and increase cost.

i. If the partnership is formalized in a written agreement provide a copy of that agreement.

ii. If the partnership has not been formalized, provide a short description of the project management role, financial commitment, or other contribution to the project for the applicant and co-applicant and any additional partners.

**Answer:**

Augusta County and MGW/Lingo have entered into Public-Private Partnership agreements in the past and have been successful implemented projects, including projects that included State funding. MGW/Lingo is a telecommunications utility and will be handling all the middle-mile and last-mile construction with its own buried fiber and fiber splicing crews. In addition, MGW/Lingo has included the costs for their engineering and permitting at no cost (value-added item) in the scope of the project. Therefore, this project is a 100% construction project. The local government co-applicant will assist with informing the residents in the project area and achieving the



# Application to DHCD Submitted through CAMS

Augusta County

Augusta County VATI 2019 Middlebrook

---

greatest take-rate possible. A draft of the Public-Private Partnership agreement is attached to the application for review.

see attachment:

*#6 - Draft PPP Agreement*

## 15. Project Budget and Cost Appropriateness

Applicants shall provide a detailed budget as to how the grant funds will be utilized, including an itemization of equipment and construction costs and a justification of proposed expenses. Expenses should be substantiated by clear cost estimates.

### Answer:

Partnering ISP will be performing all the construction, so no other contractors will be necessary for the project. This includes both the middle-mile and the last-mile components of the proposed project. Since the price of fiber cable fluctuates frequently, the partnering ISP has several vendors it uses for purchasing large amounts of cable (i.e. 10,000-20,000' reels) and will purchase the cable needed for this project immediately upon the signing of the pre-contract agreements and VATI contract. Similar to the cost for fiber plow machine, directional bore machines, rock saws, fiber splicing equipment, etc.- the cost of the fiber cable is built into our costs/rates for buried mainline fiber and buried service drops. The budget, like the scope, have been kept very simple in order to maximize the amount of fiber (broadband) deployment during the 1-year contract period. Below are the handful of line items that will be used to track the progress of the project:

• Middle-mile Fiber Construction (5.3 miles installed)	\$276,925
• Pedestals/Handholes (25)	\$12,500
• Enclosures/Splitters/Splice Trays	\$6,500
• Last-mile Fiber (30 FTTH connections)	\$45,000
• Customer ONT/CPE (30 customers)	\$6,500
• Network Engineering & Permitting	\$0.00 (in-house)
<b>Total Project Cost</b>	<b>\$347,425</b>

Here the line items above have been categorized into middle-mile and last-mile components:

• 5.3 miles of middle-mile fiber construction	\$295,925
• 1.7 miles of last-mile service drops (\$1,500 x 30 FTTH)	\$51,500
<b>Total Project Cost</b>	<b>\$347,425</b>

Unless otherwise instructed by DHCD, all remittances will identify and pull from the funding sources in the same proportions described in the matching funds section- 70/15/15.

# Application to DHCD Submitted through CAMS

Augusta County

Augusta County VATI 2019 Middlebrook

---

16. The cost benefit index is comprised of three factors: (i) state share for the total project cost, (ii) state cost per unit passed, and (iii) the internet speed. From these statistics, individual cost benefit scores are calculated. Finally, the three component scores are averaged together and converted to a 30 point scale to form a composite score.

**Answer:**

Cost Benefit Index

(i) State share of both middle-mile and last-mile = \$243,197.50

(ii) State cost per unit passed (see match at bottom of this section):

- over 5 miles of middle-mile fiber in an area with no fiber presence
- MGW/Lingo will provide a FTTH installation up to 1,000' in length at no cost to the customer
- 141 addresses within 1,000' of middle-mile cable
- 30 FTTH installations included in scope due to 1-yr contract
- over 5 miles of middle-mile fiber in an area with no fiber presence

(iii) Internet Speed available in the project area is up to 1 Gbps

$\$243,197.50 / 141 \text{ addresses passed} = \$1,724.80$

17. A description of applicant and co-applicant's history or experience with managing grants and constructing broadband communications facilities in the Commonwealth of Virginia and elsewhere.

**Answer:**

MGW Telephone was incorporated in 1967 with the mission of bringing telecommunications services to the rural communities of the Shenandoah Valley region. MGW Networks was formed in 1999 and Lingo Networks in 2011, and currently provide telecommunications services in 11 counties in Virginia. MGW & Lingo Networks transports local, LD and internet traffic for Verizon landline, Verizon wireless, Highland Telephone Cooperative, TDS Telephone, Lumos, AT&T, and New Hope Cooperative. MGW maintains over 250 miles of active fiber in the western part of Virginia. We have fiber installation buried crew, in house engineering, splicing crew, network managed services, NOC, and carrier equipment manufacturing.

MGW employs a Strategic Planning Director with over a decade of experience managing grants, including broadband planning and broadband implementation grants. MGW/Lingo was a co-applicant on a successful 2017 VATI application whereby several miles of middle-mile fiber was installed, approximately 40 FTTH connections were made, and a new 195' tower was constructed to facilitate fixed wireless services in the areas where fiber build-out may be 10+ years out.

The County has received and successfully managed many grants over the years, including Homeland Security, Watershed Rehabilitation Program, Edward Byrne Memorial Justice Assistance Grant Program, Highway Planning and Construction, and Staffing for Adequate Fire and Emergency Response (SAFER).

# Application to DHCD Submitted through CAMS

Augusta County

Augusta County VATI 2019 Middlebrook

---

Jennifer Whetzel is the Deputy County Administrator for Augusta County. In this role, she oversees the Finance, IT, Parks & Recreation, Library and ECC departments. Prior to her current position, Ms. Whetzel worked for a regional public accounting firm and as the Finance Director for the County. In this role, she managed several key functions, including grant reporting. She prepared the application for the 2016 Virginia Telecommunications Planning Initiative Grant (VATPI) and 2017 Virginia Telecommunications Initiative (VATI), both of which were awarded to the County by the Virginia Department of Housing and Community Development.

see attachment:

*#10 - Match Source*

## 18. Service

Describe the Internet service offerings to be provided after completion of this project and your price structure for these services. The service offerings should include all relevant tiers.

### **Answer:**

Below are MGW/Lingo's standard fiber internet packages currently listed on their fiber internet service application. Custom packages with speeds up to 1 Gbps are available upon request.

SILVER25Mb Download x 5 Mbps Upload  
GOLD50Mb Download x 10 Mbps Upload  
PLATINUM100Mb Download x 20 Mbps Upload  
PLATINUM ELITE200Mb Download x 40 Mbps Upload

## 19. Additional Information

Any other equitable factor that the applicant desires to include.

### **Answer:**

N/A

### **Attachments:**

Derivation of Cost (Project Budget)

1DerivationofCostsWorksheet12122018123701.pdf

Project Management Plan

2ProjectManagementPlan1212201891528.pdf

Supporting documentation for costs estimates

3CostEstimates1212201834421.pdf

# Application to DHCD Submitted through CAMS

Augusta County

Augusta County VATI 2019 Middlebrook

---

Map(s) of project area, including proposed infrastructure

4ProjectAreaMap1212201844327.pdf

Map(s) or schematic of existing broadband providers (inventory of existing assets)

5ExistingProviders1212201833519.pdf

Documentation of relationship between applicant and co-applicant (formal or informal)

6DraftPPPAgreement1212201833512.pdf

Two most recent Form 477 submitted to FCC

7Form477filings12122018123614.pdf

Documentation for in-kind contributions, including value(s)

8InKind1212201834324.pdf

Documentation supporting project costs (i.e. vendor quotes)

9ProjectCosts1212201834334.pdf

Documentation of source of match funding

10MatchSource1212201891538.pdf

Documentation that proposed project area is unserved based on VATI criteria

11Unserved1212201851705.pdf

Documentation that proposed project area is not designated for Connect America Funding (CAF)

12CAFMiddlebrook12122018123716.pdf

Funding Sources Table

13FundingSourcesTable1212201845837.pdf

(Optional) || Outreach Documentation (Question #2)

Opt1OutreachDocs1212201822412.pdf

# Application to DHCD Submitted through CAMS

Augusta County

Augusta County VATI 2019 Middlebrook

---

(Optional)

Opt2CAIBusiness1212201891543.pdf

(Optional)

Opt3NetworkDiagrams1212201895555.pdf

(Optional)

Opt4KeyPersonnel1212201891549.pdf

### Derivation of Cost Worksheet

*VATI 2019 Application - Augusta County - Middlebrook Fiber Project - Attachment #1*

Product	Total	VATI	Non-VATI	Source of Estimate	Date
<u>Construction</u>					
5.3 miles of middle-mile fiber (includes network appurtances)	\$ 295,925.00	\$ 207,147.50	\$ 88,777.50	Lingo Networks	10/30/2018
1.7 miles of last-mile fiber and FTTH (includes CPE- customer premise equipment)	\$ 51,500.00	\$ 36,050.00	\$ 15,450.00	Lingo Networks	10/30/2018
Engineering & Permitting (performed in-house at Lingo Networks; valued at 10% project cost)	\$ -	\$ -	\$ -	Lingo Networks	10/30/2018
TOTAL	\$ 347,425.00	\$ 243,197.50	\$ 104,227.50		





December 3, 2018

Ms. Jennifer M. Whetzel  
Deputy County Administrator  
County of Augusta  
Verona, Virginia 24482

RE: Cost Estimates for Middlebrook Fiber Project

Dear Ms. Whetzel,

The cost estimates provided by MGW/Lingo Networks (“Lingo”) for the Middlebrook Fiber Project were derived from (1) the standard materials costs quoted by our vendors, (2) Lingo’s standard installation costs for buried fiber optic cable, and (3) costs from recent projects of similar size and outcomes.

Having deployed fiber in a variety of locations in the Shenandoah Valley area, our cost estimates for main cable construction vary based upon terrain and available public right-of-way. For service drops, our policy is to provide a free installation up to 1,000’ in length and for that portion of the project. Due to varying distances and terrain, the average cost of \$1,500 per FTTH installation.

Below is a table which lists the project materials, installations, and vendor/installer for each:

<b>MATERIAL/INSTALLATION</b>	<b>VENDOR/INSTALLER</b>
Fiber Optic Cable, Pedestals, & Network Cabinets	Power & Tel
Middle-mile fiber construction	MGW/Lingo Networks
Fiber-to-the-Home installations	MGW/Lingo Networks

Feel free to contact me with any questions you may have at (540) 448-1336 or by sending an email to [craig.smith@mgwnetworks.com](mailto:craig.smith@mgwnetworks.com)

Sincerely,  
Lingo Networks

R. Craig Smith, President



# Middlebrook Fiber Project

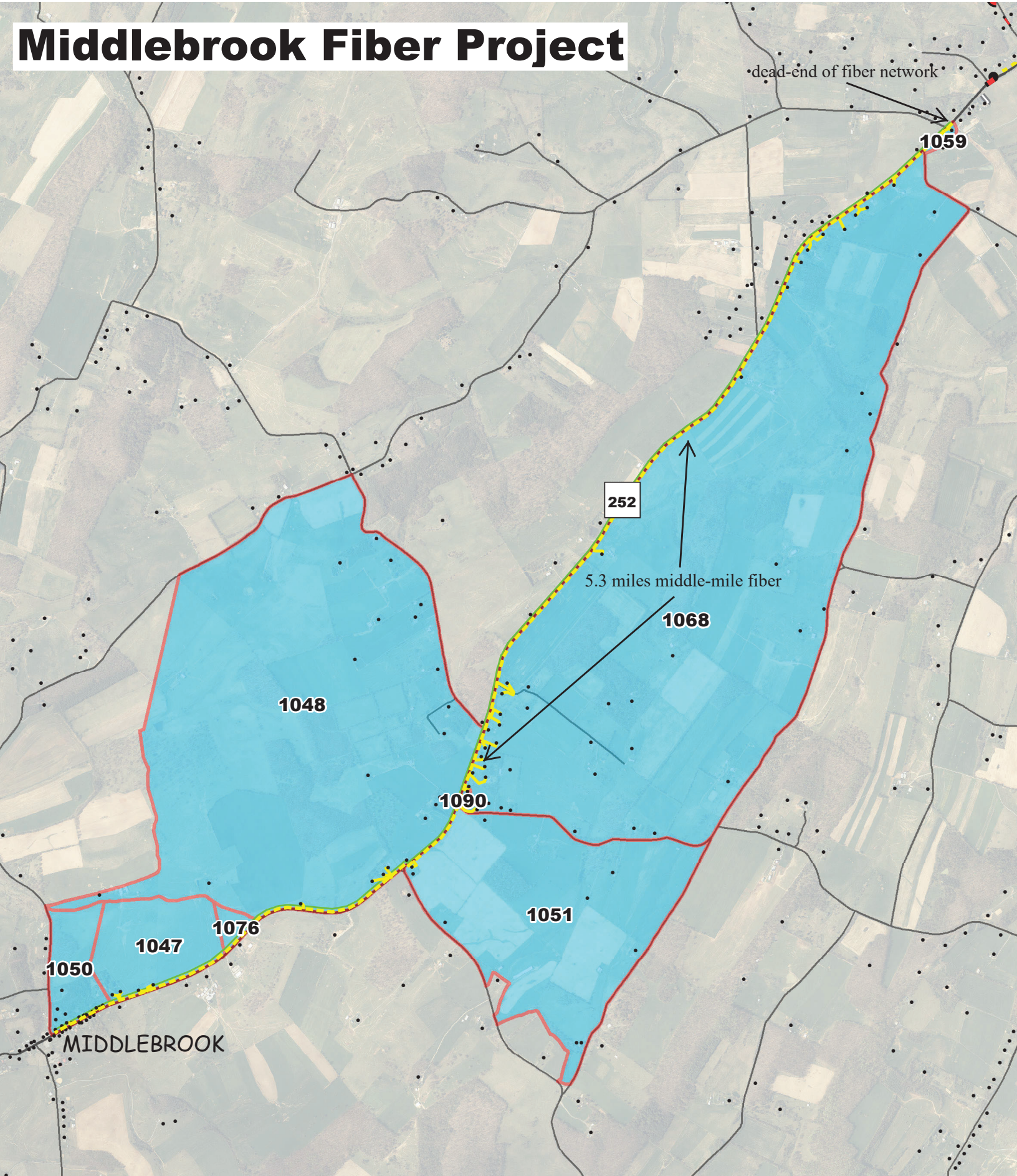

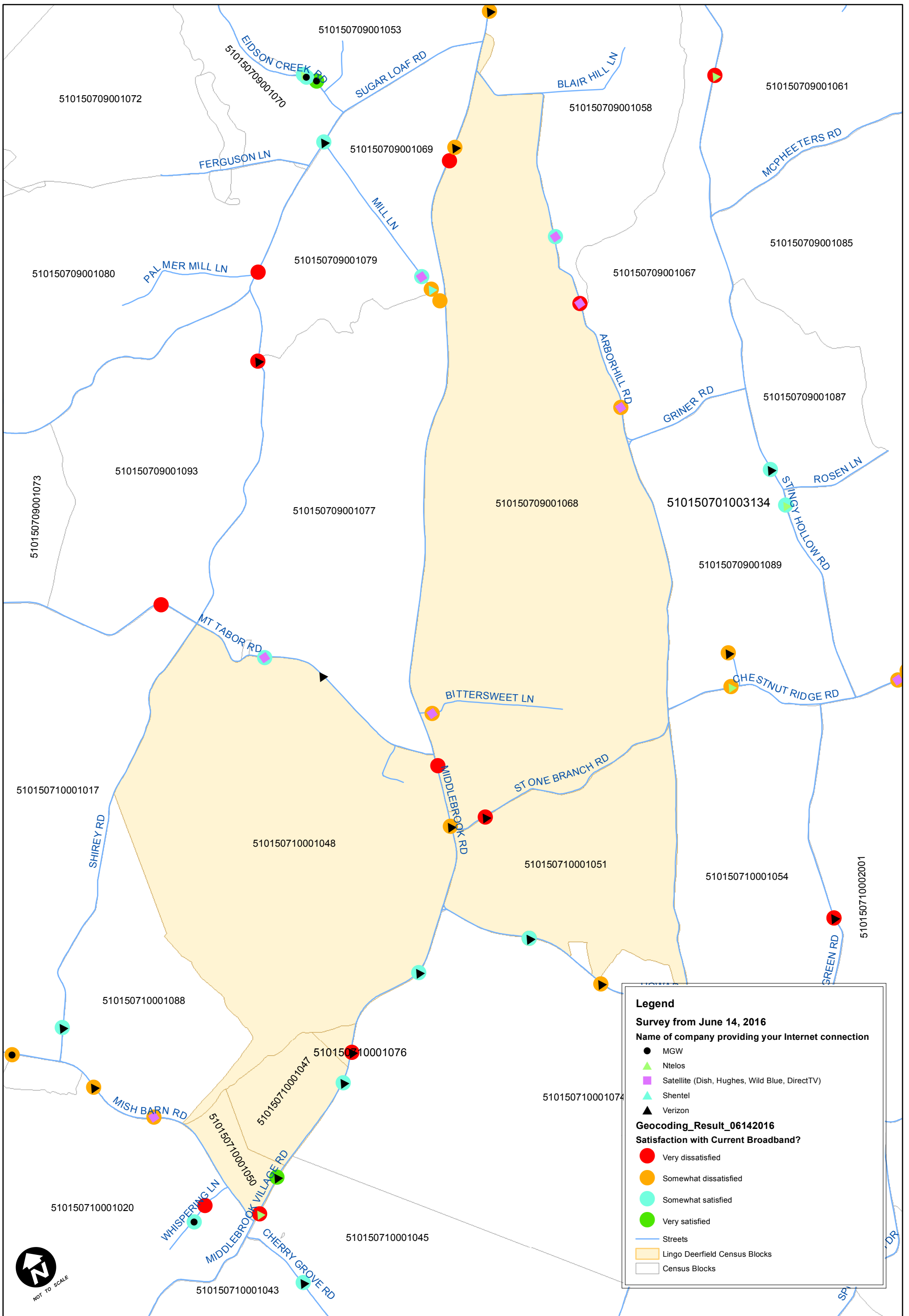

# Middlebrook Outreach Effort



## FCC Form 477 Data for Middlebrook Project Area

ProviderName	DBAName	CensusBlock	TechCode	MaxAdDown	MaxAdUp
MGW Networks, L.L.C.	MGW Networks	510150709001059	70	6	1
Rural Broadband Network Services LLC	HighSpeedLink.net	510150709001059	70	12	3
UNITED STATES CELLULAR CORPORATION	United States Cellular Corporation	510150709001059	70	1	0.2
MGW Networks, L.L.C.	MGW Networks	510150709001068	70	6	1
Verizon Virginia LLC	Verizon Virginia LLC	510150709001068	10	5	0.768
Rural Broadband Network Services LLC	HighSpeedLink.net	510150709001068	70	12	3
UNITED STATES CELLULAR CORPORATION	United States Cellular Corporation	510150709001068	70	1	0.2
King Street Wireless, L.P.	King Street Wireless L.P.	510150709001068	70	1	0.2
COMCAST CABLE COMMUNICATIONS, LLC	Comcast	510150709001068	42	0	0
MGW Networks, L.L.C.	MGW Networks	510150709001090	70	6	1
Rural Broadband Network Services LLC	HighSpeedLink.net	510150709001090	70	12	3
UNITED STATES CELLULAR CORPORATION	United States Cellular Corporation	510150709001090	70	1	0.2
King Street Wireless, L.P.	King Street Wireless L.P.	510150709001090	70	1	0.2
Rural Broadband Network Services LLC	HighSpeedLink.net	510150710001047	70	12	3
MGW Networks, L.L.C.	MGW Networks	510150710001047	70	6	1
King Street Wireless, L.P.	King Street Wireless L.P.	510150710001047	70	1	0.2
MGW Networks, L.L.C.	MGW Networks	510150710001048	70	6	1
Verizon Virginia LLC	Verizon Virginia LLC	510150710001048	10	5	0.768
Rural Broadband Network Services LLC	HighSpeedLink.net	510150710001048	70	12	3
UNITED STATES CELLULAR CORPORATION	United States Cellular Corporation	510150710001048	70	1	0.2
King Street Wireless, L.P.	King Street Wireless L.P.	510150710001048	70	1	0.2
COMCAST CABLE COMMUNICATIONS, LLC	Comcast	510150710001048	43	0	0
Rural Broadband Network Services LLC	HighSpeedLink.net	510150710001050	70	12	3
MGW Networks, L.L.C.	MGW Networks	510150710001050	70	6	1
King Street Wireless, L.P.	King Street Wireless L.P.	510150710001050	70	1	0.2
MGW Networks, L.L.C.	MGW Networks	510150710001051	70	6	1
Rural Broadband Network Services LLC	HighSpeedLink.net	510150710001051	70	12	3
Verizon Virginia LLC	Verizon Virginia LLC	510150710001051	10	5	0.768
UNITED STATES CELLULAR CORPORATION	United States Cellular Corporation	510150710001051	70	1	0.2
King Street Wireless, L.P.	King Street Wireless L.P.	510150710001051	70	1	0.2
Rural Broadband Network Services LLC	HighSpeedLink.net	510150710001076	70	12	3
MGW Networks, L.L.C.	MGW Networks	510150710001076	70	6	1

## Agreement

This agreement is made on \_\_\_\_\_, \_\_\_\_\_ between **MGW/Lingo Networks**, 27 North Central Avenue, Staunton, Virginia 24401 (“Company”), and the **County of Augusta**, Virginia, Attn: County Administrator’s Office, 18 Government Center Lane, P.O. Box 590, Verona, Virginia 24482 (“County”).

### RECITALS:

- A. Whereas, the Department of Housing and Community Development (DHCD) will be implementing the Virginia Telecommunications Initiative (VATI) grant program; and
- B. Whereas, the primary objective of the VATI is to provide financial assistance to supplement construction costs by private sector broadband service providers, in partnership with local units of government to extend service to areas that presently are unserved or underserved by any broadband provider; and
- C. Whereas, applications must be submitted by a unit of government (Towns, Cities, Counties, EDA/IDA, Broadband/Wireless Authorities, Planning District Commissions, etc.) with a private sector provider(s) as a co-applicant; and
- D. Whereas, the County has completed a Broadband Telecommunications Strategic Plan and issued a Request for Information seeking Internet Service Providers to partner with the County to submit an application for the VATI grant program; and
- E. Whereas, MGW/Lingo Networks submitted a proposal for broadband deployment solutions in the County; and
- F. Whereas, the County and MGW/Lingo Networks will partner for a grant application for the VATI grant program.

NOW, therefore, the parties agree that they will uphold the following responsibilities:

#### THE COUNTY:

1. The County will manage the VATI grant requirements with DHCD, including, but not limited to progress reports and monthly funding draws; and
2. The County will provide assistance with GIS mapping and zoning requirements throughout the project, which will be included as in-kind match for the VATI grant; and
3. The County will assist with educating the public about the project and services to be available in their areas.

#### THE COMPANY:

4. The Company will provide the County required information for the management of the VATI grant, including, but not limited to progress reports and monthly invoices; and
5. The Company will provide the required documents to the County for zoning and permit applications; and
6. The Company will design, engineer, construct and implement broadband services as designated in the VATI application by the May 30, 2020 grant deadline, and
7. The Company will guarantee that the minimum bandwidth offerings for the projects will be 25 Mbps download and 3 Mbps upload; and

8. The Company will guarantee that Verizon cellular service is available to the project area designated in the VATI application; and
9. The Company will lease or own the assets associated with the projects.

This agreement will terminate when DHCD notifies the County that all grant requirements have been satisfied.

Witness the following authorized signatures on behalf of the parties:

\_\_\_\_\_  
Date

By: \_\_\_\_\_  
R. Craig Smith  
President, MGW/Lingo Networks

\_\_\_\_\_  
Date

By: \_\_\_\_\_  
Timothy K. Fitzgerald  
County Administrator



(RETAIN FOR YOUR RECORDS)  
Form 477 Filing Summary

FRN: 0019225366

Data as of: Jun 30, 2018

Operations: Non-ILEC

Submission Status: Original - Submitted

Last Updated: Sep 3, 2018 10:37:51

### Filer Identification

Section	Question	Response
Filer Information	Provider Name	MGW Networks, L.L.C.
	Holding Company Name	MGW Communications, Inc.
	SAC ID	
	499 ID	828775
Data Contact Information	Data Contact Name	Sheri H Smith
	Data Contact Phone Number	(540) 925-5235
	Data Contact E-mail	sheri.smith@mgwnetworks.com
Emergency Operations Contact Information	Emergency Operations Name	R. Craig Smith
	Emergency Operations Phone Number	(540) 925-2258
	Emergency Operations E-mail	craig.smith@mgwnetworks.com
Certifying Official Contact Information	Certifying Official Name	Sheri H. Smith
	Certifying Official Phone Number	(540) 925-5235
	Certifying Official E-mail	sheri.smith@mgwnetworks.com

### Data Submitted

Form Section	File Name	Date & Time	Number of Rows
Fixed Broadband Deployment	477_MGWNetworksLingoDeployment_20180630.csv	Aug 30, 2018 12:43:48	6884
Fixed Broadband Subscription	477_NETWORKSLINGOBroadband Subscription_6_30_2018F.csv	Aug 28, 2018 22:55:44	238
Fixed Voice Subscription	477 NetworksLingoVoiceTelephoneSubscription_6_30_2018.csv	Aug 28, 2018 21:49:21	16



(RETAIN FOR YOUR RECORDS)  
Form 477 Filing Summary

FRN: 0019225366 | Data as of: Dec 31, 2017 | Operations: Non-ILEC | Submission Status: Revised - Submitted | Last Updated: Aug 27, 2018 16:28:28

### Filer Identification

Section	Question	Response
Filer Information	Provider Name	MGW Networks, L.L.C.
	Holding Company Name	MGW Communications, Inc.
	SAC ID	
	499 ID	828775
Data Contact Information	Data Contact Name	Sheri H Smith
	Data Contact Phone Number	(540) 925-5235
	Data Contact E-mail	sherihsmith@mgwnet.com
Emergency Operations Contact Information	Emergency Operations Name	R. Craig Smith
	Emergency Operations Phone Number	(540) 925-2258
	Emergency Operations E-mail	rcraigsmith@mgwnet.com
Certifying Official Contact Information	Certifying Official Name	Sheri H Smith
	Certifying Official Phone Number	(540) 925-5235
	Certifying Official E-mail	sherihsmith@mgwnet.com

### Data Submitted

Form Section	File Name	Date & Time	Number of Rows
Fixed Broadband Deployment	477MGWNETWORKSLINGOBROADBANDDEPLOYMENT_12312017F.csv	Jun 12, 2018 16:17:29	6877
Fixed Broadband Subscription	Revised477MGWNETWORKSLINGOBROADBANDSUBS_12312017F.csv	Jun 12, 2018 16:20:53	228
Fixed Voice Subscription	477 MGWNETWORKS VOICE SUBSCRIPTION_MKT 2 and 3_12_31_17.csv	Jun 12, 2018 16:17:29	14

There are no in-kind contributions included in the budget for the proposed project. The local and private match contributions exceed what is required by the VATI program and will be 100% cash match.





December 3, 2018

Ms. Jennifer M. Whetzel  
Deputy County Administrator  
County of Augusta  
Verona, Virginia 24482

RE: Cost Estimates for Middlebrook Fiber Project

Dear Ms. Whetzel,

The cost estimates provided by MGW/Lingo Networks (“Lingo”) for the Middlebrook Fiber Project were derived from (1) the standard materials costs quoted by our vendors, (2) Lingo’s standard installation costs for buried fiber optic cable, and (3) costs from recent projects of similar size and outcomes.

Having deployed fiber in a variety of locations in the Shenandoah Valley area, our cost estimates for main cable construction vary based upon terrain and available public right-of-way. For service drops, our policy is to provide a free installation up to 1,000’ in length and for that portion of the project. Due to varying distances and terrain, the average cost of \$1,500 per FTTH installation.

Below is a table which lists the project materials, installations, and vendor/installer for each:

<b>MATERIAL/INSTALLATION</b>	<b>VENDOR/INSTALLER</b>
Fiber Optic Cable, Pedestals, & Network Cabinets	Power & Tel
Middle-mile fiber construction	MGW/Lingo Networks
Fiber-to-the-Home installations	MGW/Lingo Networks

Feel free to contact me with any questions you may have at (540) 448-1336 or by sending an email to [craig.smith@mgwnetworks.com](mailto:craig.smith@mgwnetworks.com)

Sincerely,  
Lingo Networks

R. Craig Smith, President

**COUNTY OF AUGUSTA, VA.**

**BOARD OF SUPERVISORS**

MARSHALL W. PATTIE  
North River

GERALD W. GARBER  
Middle River

TRACY C. PYLES, JR.  
Pastures

TERRY L. KELLEY, JR.  
Beverley Manor

WENDELL L. COLEMAN  
Wayne

MICHAEL L. SHULL  
Riverheads

CAROLYN S. BRAGG  
South River

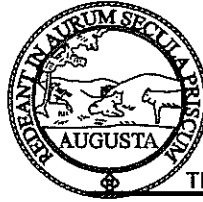

**TIMOTHY K. FITZGERALD – COUNTY ADMINISTRATOR**

**AUGUSTA COUNTY GOVERNMENT CENTER**

P.O. BOX 590, VERONA, VA 24482-0590

(540) 245-5610 FAX (540) 245-5621

coadmin@co.augusta.va.us

18-119

**M E M O R A N D U M**

TO: Jennifer Whetzel, Deputy County Administrator

FROM: Timothy K. Fitzgerald, County Administrator *TKF*

DATE: November 15, 2018

SUBJECT: Broadband Grant

The Augusta County Board of Supervisors, at its Wednesday, November 14, 2018, meeting approved submitting the VATI Grant application for the Middlebrook Fiber Project with a 15% local match in the amount of \$52,114.00 and the Deerfield Fiber Project with a 15% local match in the amount of \$34,950.00.

Funding Source: 70-80000-8145 \$87,064.00

TKF/am

cc: Misty Cook, Director of Finance



December 3, 2018

**LETTER OF COMMITMENT**

Ms. Jennifer M. Whetzel  
Deputy County Administrator  
County of Augusta  
Verona, Virginia 24482

RE: Middlebrook Fiber Project (VATI 2019)

Dear Ms. Whetzel,

MGW/Lingo Networks (“Lingo”) is very pleased to be selected as Augusta County’s partnering provider in an application for broadband funding from the Virginia Telecommunications Initiative (VATI). As you and the other staff and elected officials know from our numerous meetings, Lingo is committed to helping Augusta County identify and implement broadband solutions in the rural, unserved areas of the county.

The intent of this letter is to affirm our financial commitment of \$52,114 included in the application for the broadband deployment solution along Middlebrook Road. As we’ve previously mentioned, we applaud Augusta County for your attentiveness to the telecommunications needs throughout your communities and your local investment will undoubtedly assist with the provision of broadband services in these high-cost, unserved areas.

Feel free to contact me with any questions you may have at (540) 448-1336 or by sending an email to [craig.smith@mgwnetworks.com](mailto:craig.smith@mgwnetworks.com)

Sincerely,  
Lingo Networks

R. Craig Smith, President

## FCC Form 477 Data for Middlebrook Project Area

ProviderName	DBAName	CensusBlock	TechCode	MaxAdDown	MaxAdUp
MGW Networks, L.L.C.	MGW Networks	510150709001059	70	6	1
Rural Broadband Network Services LLC	HighSpeedLink.net	510150709001059	70	12	3
UNITED STATES CELLULAR CORPORATION	United States Cellular Corporation	510150709001059	70	1	0.2
MGW Networks, L.L.C.	MGW Networks	510150709001068	70	6	1
Verizon Virginia LLC	Verizon Virginia LLC	510150709001068	10	5	0.768
Rural Broadband Network Services LLC	HighSpeedLink.net	510150709001068	70	12	3
UNITED STATES CELLULAR CORPORATION	United States Cellular Corporation	510150709001068	70	1	0.2
King Street Wireless, L.P.	King Street Wireless L.P.	510150709001068	70	1	0.2
COMCAST CABLE COMMUNICATIONS, LLC	Comcast	510150709001068	42	0	0
MGW Networks, L.L.C.	MGW Networks	510150709001090	70	6	1
Rural Broadband Network Services LLC	HighSpeedLink.net	510150709001090	70	12	3
UNITED STATES CELLULAR CORPORATION	United States Cellular Corporation	510150709001090	70	1	0.2
King Street Wireless, L.P.	King Street Wireless L.P.	510150709001090	70	1	0.2
Rural Broadband Network Services LLC	HighSpeedLink.net	510150710001047	70	12	3
MGW Networks, L.L.C.	MGW Networks	510150710001047	70	6	1
King Street Wireless, L.P.	King Street Wireless L.P.	510150710001047	70	1	0.2
MGW Networks, L.L.C.	MGW Networks	510150710001048	70	6	1
Verizon Virginia LLC	Verizon Virginia LLC	510150710001048	10	5	0.768
Rural Broadband Network Services LLC	HighSpeedLink.net	510150710001048	70	12	3
UNITED STATES CELLULAR CORPORATION	United States Cellular Corporation	510150710001048	70	1	0.2
King Street Wireless, L.P.	King Street Wireless L.P.	510150710001048	70	1	0.2
COMCAST CABLE COMMUNICATIONS, LLC	Comcast	510150710001048	43	0	0
Rural Broadband Network Services LLC	HighSpeedLink.net	510150710001050	70	12	3
MGW Networks, L.L.C.	MGW Networks	510150710001050	70	6	1
King Street Wireless, L.P.	King Street Wireless L.P.	510150710001050	70	1	0.2
MGW Networks, L.L.C.	MGW Networks	510150710001051	70	6	1
Rural Broadband Network Services LLC	HighSpeedLink.net	510150710001051	70	12	3
Verizon Virginia LLC	Verizon Virginia LLC	510150710001051	10	5	0.768
UNITED STATES CELLULAR CORPORATION	United States Cellular Corporation	510150710001051	70	1	0.2
King Street Wireless, L.P.	King Street Wireless L.P.	510150710001051	70	1	0.2
Rural Broadband Network Services LLC	HighSpeedLink.net	510150710001076	70	12	3
MGW Networks, L.L.C.	MGW Networks	510150710001076	70	6	1

The map below depicts approx. 3,070 census blocks reported by Rural Broadband Network Services, LCC (RBNS) including the 8 census blocks in the proposed project area (yellow outline). RBNS has reported providing fixed wireless internet of with speeds of 12/3 in the entire red area. If this was true, then broadband (>10/1 per VATI guidelines) would be available in 95% of the County. Based upon our local knowledge of the area and our survey results, we do not believe this information to be correct and that the Middlebrook Fiber Project is meets the definition of unserved and is eligible for VATI.

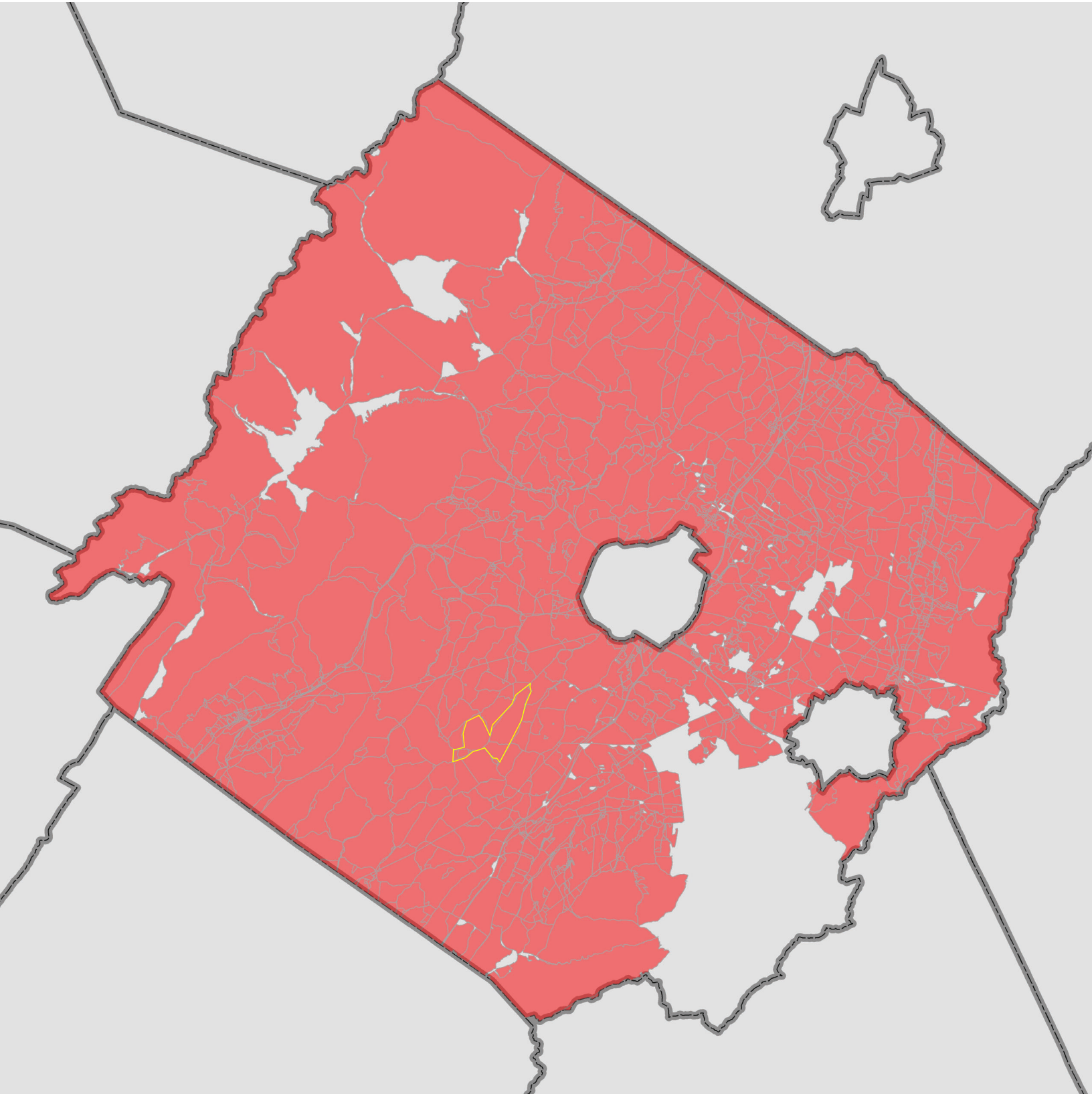

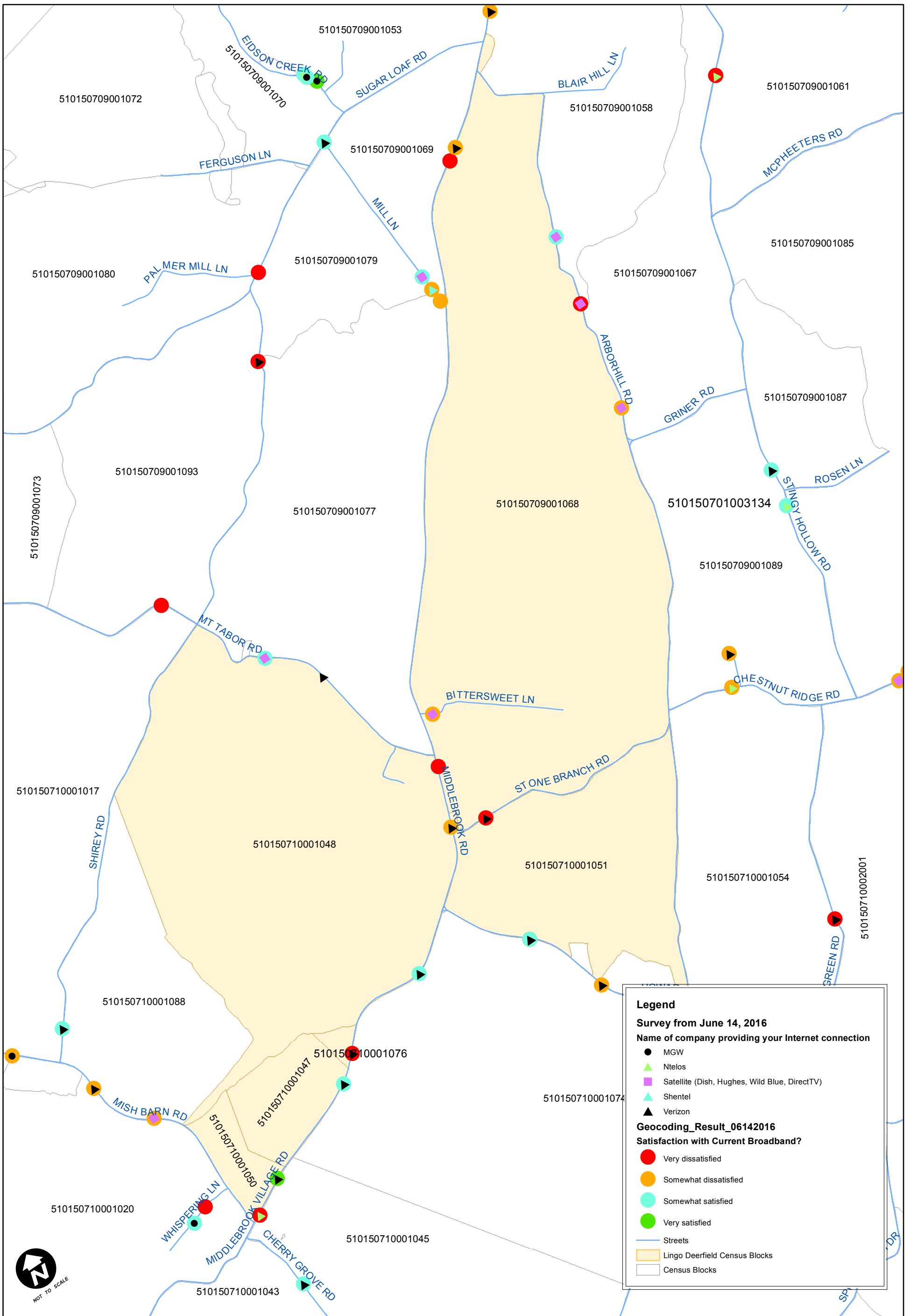

# Middlebrook Outreach Effort



The image below is a screenshot that was taken from the FCC's Connect America Fund Broadband Map. This interactive map shows the areas where Connect America Funding has been allocated. The proposed project area is not located in an area that has been designated to receive Connect America Funding (CAF). <https://data.usac.org/publicreports/caf-map/>

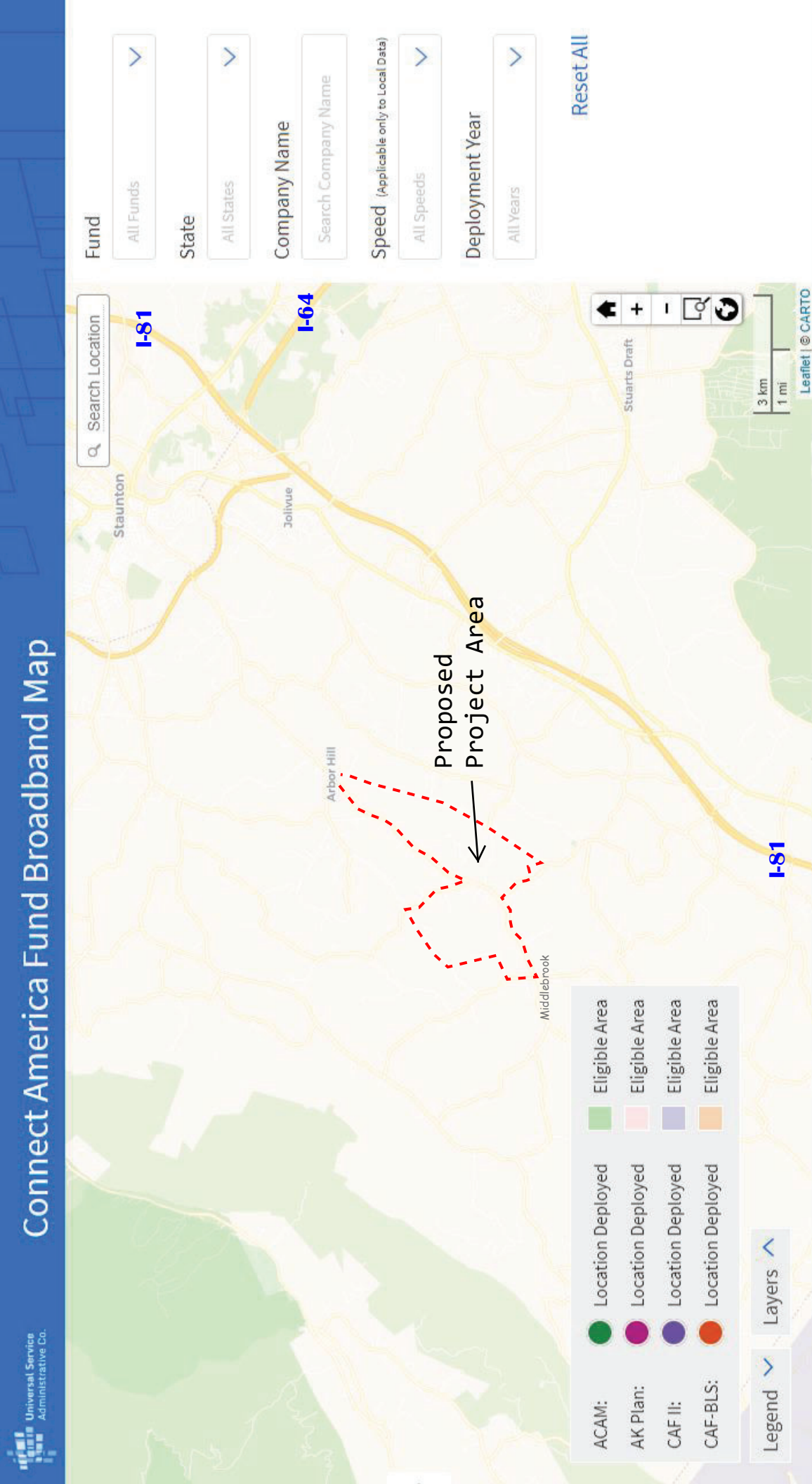

# VATI 2019 Application - Augusta County - Middlebrook Fiber Project

VATI FUNDING SOURCES TABLE

Please fill in the chart below with a description of the project funding source (local, federal, state, private, other), the amount from that source, the percentage of total project funding that source represents, and a description of the current status of the funds (pending, secured, etc.).

Source	Amount	%	Status
REQUESTED VATI	\$ 243,197.50	70	Pending
LOCAL	\$ 52,113.75	15	SECURED
PRIVATE	\$ 52,113.75	15	SECURED
	\$		
	\$		
	\$		
	\$		
<b>TOTAL</b>	<b>\$ 347,425.00</b>	<b>100 %</b>	



**A G E N D A**  
REGULAR MEETING OF THE AUGUSTA COUNTY BOARD OF SUPERVISORS

**WEDNESDAY, NOVEMBER 28, 2018, at 7:00 p.m.**

**Board Meeting Room, Government Center, Verona, VA**

---

ITEM NO.	DESCRIPTION
<b>7:00 P.M.</b>	<b>PLEDGE OF ALLEGIANCE</b>
	<b>INVOCATION</b> - Public participation is optional; those who wish to join the Board of Supervisors in prayer are asked to remain standing after the Pledge.
<b>PUBLIC HEARING:</b>	
11-13	<b><u>CRESCENT DEVELOPMENT GROUP, LLC AND MYERS CORNER PARTNERS, LC – REZONING</u></b> Consider a request to rezone from Multi-Family Residential to General Business approximately 0.345 acres (portion of TMP 066C1-8-1 and portion of TMP 066C-8-11) owned by Crescent Development Group, LLC and Myers Corner Partners, LC located in the southwest quadrant of the intersection of Jefferson Highway (Route 250) and Myers Corner Drive in Fishersville in the Wayne District. The Planning Commission recommends approval.
11-14	<b><u>CRIMORA-MADRID AGRICULTURAL AND FORESTAL DISTRICT</u></b> Consider an ordinance amendment of Chapter 3 of the Augusta County Code for the Crimora-Madrid Agricultural and Forestal District located in the Middle River District lying between Route 784 (Pine Bluff Road) and Route 865 (Rockfish Road) and south of Route 612 (New Hope and Crimora Road). The amended approximate acreage of the district is 1,099. The amendment will renew the existing district, with additions, until November 24, 2028.
11-15	<b><u>MIDDLE RIVER AGRICULTURAL AND FORESTAL DISTRICT</u></b> Consider an ordinance amendment of Chapter 3 of the Augusta County Code for the Middle River Agricultural and Forestal District located in the Middle River District, lying east of Interstate 81; both east and west sides of Route 778 (Knightly Mill Road), Route 774 (Broad Run Road), Route 774 (Cline River Road), and Route 865 (Rockfish Road); both north and south sides of Route 608 (Battlefield Road), Route 775 (Buttermilk Road), and Route 775 (Craig Shop Road); on the north side of Route 777 (Knightly Lane); both north and south sides of Route 728 (Patterson Mill Road); on the southwest side of Route 774 (Piedmont Road). The amendment will clarify that parcels within the district are also located on Dam Town Road. The amended approximate acreage of the district is 5,575 acres. The amendment will renew the existing district, with the corrections, additions and removals, until November 24, 2028.

11-16            **LEASE OF BERRY FARM HAY AND PASTURE**  
Consider authorizing the lease of the property owned by Augusta County, Virginia, Tax Map 36-19 and better known as the Berry Farm Hay and Pasture area in the Beverley Manor District.

**\*\* (END OF PUBLIC HEARINGS) \*\***

11-17            **MATTERS TO BE PRESENTED BY THE PUBLIC**\*\*\*Chairman Gerald Garber announced that this would be the time for the public to comment on Broadband.\*\*\*

11-18            **REFUND REQUEST FOR STANLEY N. THOMPSON**  
Consider a refund request from the Commissioner of the Revenue for Stanley N. Thompson in the amount of \$2,872.89.

11-19            **LEGISLATIVE AGENDA**  
Consider final Legislative Agenda.

11-20            **COMMISSIONER OF REVENUE TAX PROGRAM**  
Consider Tax Relief for the Elderly and Disabled.

11-21            **WAIVERS**

11-22            **CONSENT AGENDA**

11-22.1

**MINUTES**

Consider minutes of the following meeting:

- Regular Meeting, Wednesday, October 10, 2018
- Staff Briefing, Monday, October 22, 2018

**(END OF CONSENT AGENDA)**

11-23            **MATTERS TO BE PRESENTED BY THE BOARD**

11-24            **MATTERS TO BE PRESENTED BY STAFF**

11-25            **CLOSED SESSION**



## Legal Notices

### PUBLIC COMMENT PERIOD-2019 VATI GRANT

The County of Augusta is soliciting public comment before pursuing applications for the 2019 Virginia Telecommunications Initiative (VATI) Grant implemented by the Virginia Department of Housing and Community Development. The goal of the VATI grant is to enhance sustainability and competitive advantages of communities throughout the Commonwealth by preparing those communities to build, utilize, and capitalize on telecommunications infrastructure. The County received a proposal to partner for fiber projects in the areas of Rt. 252 from Arbor Hill to Middlebrook and in the Deerfield Valley Road and Marble Valley Road vicinities of the Deerfield community.

The Board of Supervisors will hear public comment on the grant at the November 28, 2018 regular meeting. The meeting begins at 7 pm and is held at the Government Center at 18 Government Center Lane, Verona, VA 24482. Written comments can be submitted to Information Technology at P.O. Box 590, Verona, VA 24482. If you have questions regarding the public comment, please call 540-245-5062.

0903260814-01

# All County News

Font Size:    [Share & Bookmark](#) [Feedback](#)  [Print](#)

## **Internet Survey for Augusta County**

**Post Date:** 11/16/2018 4:17 PM

The County of Augusta is soliciting public comment before pursuing an application for the 2019 *Virginia Telecommunications Initiative Grant* implemented by the Virginia DHCD.

The County received a proposal to partner for fiber projects in the areas of Rt. 252 from Arbor Hill to Middlebrook and in the Deerfield Valley Road and Marble Valley Road vicinities of the Deerfield community.

**Please assist County officials in defining the need for improved internet service by completing the following survey.**

<https://www.surveymonkey.com/r/AugustaCountyBroadband>

[Return to full list >>](#)

COUNTY OF AUGUSTA, VA.

BOARD OF SUPERVISORS

MARSHALL W. PATTIE  
North River

GERALD W. GARBER  
Middle River

PAMELA L. CARTER  
Pastures

WENDELL L. COLEMAN  
Wayne

TERRY L. KELLEY, JR.  
Beverley Manor

MICHAEL L. SHULL  
Riverheads

CAROLYN S. BRAGG  
South River



TIMOTHY K. FITZGERALD – COUNTY ADMINISTRATOR

AUGUSTA COUNTY GOVERNMENT CENTER

P.O. BOX 590, VERONA, VA 24482-0590

(540) 245-5610 FAX (540) 245-5621

coadmin@co.augusta.va.us

November 27, 2018

Property Owner  
Middlebrook Community

RE: Internet Survey

Dear Property Owner:

Augusta County is applying for a Virginia Telecommunications Initiative 2019 grant for portions of the Middlebrook area. The project would include installation of fiber to the home. Your property may or may not be in the qualifying project area, however, your input is critical to beginning the process of extending service availability to unserved areas. Responses to the following questions will be included with public input for the grant:

Do you have internet service at your location?      Yes      No

If so, are you satisfied with your service?      Yes      No

Who is your current internet provider?      \_\_\_\_\_

Thank you for taking the time to complete this short survey. Please return it in the enclosed envelope. If you are interested in completing the County's full Internet survey, go to [www.co.augusta.va.us](http://www.co.augusta.va.us) and see the survey under news and notices.

Sincerely,  
County of Augusta

**COUNTY OF AUGUSTA, VA.**

**BOARD OF SUPERVISORS**

MARSHALL W. PATTIE  
North River

GERALD W. GARBER  
Middle River

PAMELA L. CARTER  
Pastures

VACANT  
Beverley Manor

WENDELL L. COLEMAN  
Wayne

MICHAEL L. SHULL  
Riverheads

CAROLYN S. BRAGG  
South River



**TIMOTHY K. FITZGERALD – COUNTY ADMINISTRATOR**

**AUGUSTA COUNTY GOVERNMENT CENTER**

P.O. BOX 590, VERONA, VA 24482-0590

(540) 245-5610 FAX (540) 245-5621

coadmin@co.augusta.va.us

November 27, 2018

Property Owner  
Middlebrook Community

RE: Internet Survey

Dear Property Owner:

Augusta County is applying for a Virginia Telecommunications Initiative 2019 grant for portions of the Middlebrook area. The project would include installation of fiber to the home. Your property may or may not be in the qualifying project area, however, your input is critical to beginning the process of extending service availability to unserved areas. Responses to the following questions will be included with public input for the grant:

Do you have internet service at your location?    Yes     No

If so, are you satisfied with your service?    Yes    No

Who is your current internet provider? \_\_\_\_\_

Thank you for taking the time to complete this short survey. Please return it in the enclosed envelope. If you are interested in completing the County's full Internet survey, go to [www.co.augusta.va.us](http://www.co.augusta.va.us) and see the survey under news and notices.

Sincerely,  
County of Augusta

COUNTY OF AUGUSTA, VA.

BOARD OF SUPERVISORS

MARSHALL W. PATTIE  
North River

GERALD W. GARBER  
Middle River

PAMELA L. CARTER  
Pastures

VACANT  
Beverly Manor

WENDELL L. COLEMAN  
Wayne

MICHAEL L. SHULL  
Riverheads

CAROLYN S. BRAGG  
South River



TIMOTHY K. FITZGERALD – COUNTY ADMINISTRATOR

AUGUSTA COUNTY GOVERNMENT CENTER

P.O. BOX 590, VERONA, VA 24482-0590

(540) 245-5610 FAX (540) 245-5621

coadmin@co.augusta.va.us

November 27, 2018

Property Owner  
Middlebrook Community

240 BOWMAN SPRINGS RD.

RE: Internet Survey

Dear Property Owner:

Augusta County is applying for a Virginia Telecommunications Initiative 2019 grant for portions of the Middlebrook area. The project would include installation of fiber to the home. Your property may or may not be in the qualifying project area, however, your input is critical to beginning the process of extending service availability to unserved areas. Responses to the following questions will be included with public input for the grant:

Do you have internet service at your location? Yes  No

If so, are you satisfied with your service? Yes  No

Who is your current internet provider? ONLY "HUGES.NET" IS AVAILABLE. THEIR SERVICE IS TERRIBLE.

Thank you for taking the time to complete this short survey. Please return it in the enclosed envelope. If you are interested in completing the County's full Internet survey, go to [www.co.augusta.va.us](http://www.co.augusta.va.us) and see the survey under news and notices.

Sincerely,  
County of Augusta

**COUNTY OF AUGUSTA, VA.**

**BOARD OF SUPERVISORS**

MARSHALL W. PATTIE  
North River

GERALD W. GARBER  
Middle River

PAMELA L. CARTER  
Pastures

WENDELL L. COLEMAN  
Wayne

VACANT  
Beverley Manor

MICHAEL L. SHULL  
Riverheads

CAROLYN S. BRAGG  
South River



**TIMOTHY K. FITZGERALD – COUNTY ADMINISTRATOR**

**AUGUSTA COUNTY GOVERNMENT CENTER**

P.O. BOX 590, VERONA, VA 24482-0590

(540) 245-5610 FAX (540) 245-5621

coadmin@co.augusta.va.us

November 27, 2018

Property Owner  
Middlebrook Community

RE: Internet Survey

Dear Property Owner:

Augusta County is applying for a Virginia Telecommunications Initiative 2019 grant for portions of the Middlebrook area. The project would include installation of fiber to the home. Your property may or may not be in the qualifying project area, however, your input is critical to beginning the process of extending service availability to unserved areas. Responses to the following questions will be included with public input for the grant:

Do you have internet service at your location?

Yes    No

If so, are you satisfied with your service?

Yes    No *Sometimes lot of times NOT*

Who is your current internet provider?

MGW

Thank you for taking the time to complete this short survey. Please return it in the enclosed envelope. If you are interested in completing the County's full Internet survey, go to [www.co.augusta.va.us](http://www.co.augusta.va.us) and see the survey under news and notices.

Sincerely,  
County of Augusta



**COUNTY OF AUGUSTA, VA.**

**BOARD OF SUPERVISORS**

MARSHALL W. PATTIE  
North River

GERALD W. GARBER  
Middle River

PAMELA L. CARTER  
Pastures

VACANT  
Beverly Manor

WENDELL L. COLEMAN  
Wayne

MICHAEL L. SHULL  
Riverheads

CAROLYN S. BRAGG  
South River



**TIMOTHY K. FITZGERALD – COUNTY ADMINISTRATOR**

**AUGUSTA COUNTY GOVERNMENT CENTER**

P.O. BOX 590, VERONA, VA 24482-0590

(540) 245-5610 FAX (540) 245-5621

coadmin@co.augusta.va.us

November 27, 2018

Property Owner  
Middlebrook Community

RE: Internet Survey

Dear Property Owner:

Augusta County is applying for a Virginia Telecommunications Initiative 2019 grant for portions of the Middlebrook area. The project would include installation of fiber to the home. Your property may or may not be in the qualifying project area, however, your input is critical to beginning the process of extending service availability to unserved areas. Responses to the following questions will be included with public input for the grant:

Do you have internet service at your location?  Yes  No

If so, are you satisfied with your service?  Yes  No

Who is your current internet provider?

MEW

Thank you for taking the time to complete this short survey. Please return it in the enclosed envelope. If you are interested in completing the County's full Internet survey, go to [www.co.augusta.va.us](http://www.co.augusta.va.us) and see the survey under news and notices.

Sincerely,  
County of Augusta

**COUNTY OF AUGUSTA, VA.**

**BOARD OF SUPERVISORS**

MARSHALL W. PATTIE  
North River

GERALD W. GARBER  
Middle River

PAMELA L. CARTER  
Pastures

WENDELL L. COLEMAN  
Wayne

VACANT  
Beverley Manor

MICHAEL L. SHULL  
Riverheads

CAROLYN S. BRAGG  
South River

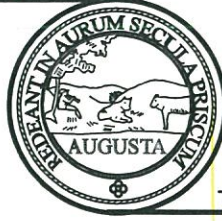

**TIMOTHY K. FITZGERALD – COUNTY ADMINISTRATOR**

**AUGUSTA COUNTY GOVERNMENT CENTER**

P.O. BOX 590, VERONA, VA 24482-0590

(540) 245-5610 FAX (540) 245-5621

coadmin@co.augusta.va.us

November 27, 2018

Property Owner  
Middlebrook Community

RE: Internet Survey

Dear Property Owner:

Augusta County is applying for a Virginia Telecommunications Initiative 2019 grant for portions of the Middlebrook area. The project would include installation of fiber to the home. Your property may or may not be in the qualifying project area, however, your input is critical to beginning the process of extending service availability to unserved areas. Responses to the following questions will be included with public input for the grant:

Do you have internet service at your location?  Yes  No

If so, are you satisfied with your service? Yes  No

Who is your current internet provider? VERIZON

Thank you for taking the time to complete this short survey. Please return it in the enclosed envelope. If you are interested in completing the County's full Internet survey, go to [www.co.augusta.va.us](http://www.co.augusta.va.us) and see the survey under news and notices.

Sincerely,  
County of Augusta

**COUNTY OF AUGUSTA, VA.**

**BOARD OF SUPERVISORS**

MARSHALL W. PATTIE  
North River

PAMELA L. CARTER  
Pastures

MICHAEL L. SHULL  
Riverheads

GERALD W. GARBER  
Middle River

WENDELL L. COLEMAN  
Wayne

CAROLYN S. BRAGG  
South River



VACANT  
Beverley Manor

**TIMOTHY K. FITZGERALD – COUNTY ADMINISTRATOR**

**AUGUSTA COUNTY GOVERNMENT CENTER**

P.O. BOX 590, VERONA, VA 24482-0590

(540) 245-5610 FAX (540) 245-5621

coadmin@co.augusta.va.us

November 27, 2018

Property Owner  
Middlebrook Community

RE: Internet Survey

Dear Property Owner:

Augusta County is applying for a Virginia Telecommunications Initiative 2019 grant for portions of the Middlebrook area. The project would include installation of fiber to the home. Your property may or may not be in the qualifying project area, however, your input is critical to beginning the process of extending service availability to unserved areas. Responses to the following questions will be included with public input for the grant:

Do you have internet service at your location?  Yes  No

If so, are you satisfied with your service? Yes  No

Who is your current internet provider?

AT+T

Thank you for taking the time to complete this short survey. Please return it in the enclosed envelope. If you are interested in completing the County's full Internet survey, go to [www.co.augusta.va.us](http://www.co.augusta.va.us) and see the survey under news and notices.

Sincerely,  
County of Augusta

COUNTY OF AUGUSTA, VA.

BOARD OF SUPERVISORS

MARSHALL W. PATTIE  
North River

GERALD W. GARBER  
Middle River

PAMELA L. CARTER  
Pastures

VACANT  
Beverly Manor

WENDELL L. COLEMAN  
Wayne

MICHAEL L. SHULL  
Riverheads

CAROLYN S. BRAGG  
South River



TIMOTHY K. FITZGERALD – COUNTY ADMINISTRATOR

AUGUSTA COUNTY GOVERNMENT CENTER

P.O. BOX 590, VERONA, VA 24482-0590

(540) 245-5610 FAX (540) 245-5621

coadmin@co.augusta.va.us

November 27, 2018

Property Owner  
Middlebrook Community

RE: Internet Survey

Dear Property Owner:

Augusta County is applying for a Virginia Telecommunications Initiative 2019 grant for portions of the Middlebrook area. The project would include installation of fiber to the home. Your property may or may not be in the qualifying project area, however, your input is critical to beginning the process of extending service availability to unserved areas. Responses to the following questions will be included with public input for the grant:

Do you have internet service at your location?  Yes  No

If so, are you satisfied with your service? Yes  No !!!

Who is your current internet provider? Lingo Networks - MGW

Thank you for taking the time to complete this short survey. Please return it in the enclosed envelope. If you are interested in completing the County's full Internet survey, go to [www.co.augusta.va.us](http://www.co.augusta.va.us) and see the survey under news and notices.

Sincerely,  
County of Augusta

**COUNTY OF AUGUSTA, VA.**

**BOARD OF SUPERVISORS**

MARSHALL W. PATTIE  
North River

PAMELA L. CARTER  
Pastures

MICHAEL L. SHULL  
Riverheads

VACANT  
Beverley Manor

GERALD W. GARBER  
Middle River

WENDELL L. COLEMAN  
Wayne

CAROLYN S. BRAGG  
South River



**TIMOTHY K. FITZGERALD – COUNTY ADMINISTRATOR**

**AUGUSTA COUNTY GOVERNMENT CENTER**

P.O. BOX 590, VERONA, VA 24482-0590

(540) 245-5610 FAX (540) 245-5621

coadmin@co.augusta.va.us

November 27, 2018

Property Owner  
Middlebrook Community

RE: Internet Survey

Dear Property Owner:

Augusta County is applying for a Virginia Telecommunications Initiative 2019 grant for portions of the Middlebrook area. The project would include installation of fiber to the home. Your property may or may not be in the qualifying project area, however, your input is critical to beginning the process of extending service availability to unserved areas. Responses to the following questions will be included with public input for the grant:

Do you have internet service at your location?  Yes  No

If so, are you satisfied with your service?  Yes  No

Who is your current internet provider?

Hughes NET

Thank you for taking the time to complete this short survey. Please return it in the enclosed envelope. If you are interested in completing the County's full Internet survey, go to [www.co.augusta.va.us](http://www.co.augusta.va.us) and see the survey under news and notices.

Sincerely,  
County of Augusta

COUNTY OF AUGUSTA, VA.

BOARD OF SUPERVISORS

MARSHALL W. PATTIE  
North River

GERALD W. GARBER  
Middle River

PAMELA L. CARTER  
Pastures

VACANT  
Beverley Manor

WENDELL L. COLEMAN  
Wayne

MICHAEL L. SHULL  
Riverheads

CAROLYN S. BRAGG  
South River



TIMOTHY K. FITZGERALD – COUNTY ADMINISTRATOR

AUGUSTA COUNTY GOVERNMENT CENTER

P.O. BOX 590, VERONA, VA 24482-0590

(540) 245-5610 FAX (540) 245-5621

coadmin@co.augusta.va.us

November 27, 2018

Property Owner  
Middlebrook Community

RE: Internet Survey

Dear Property Owner:

Augusta County is applying for a Virginia Telecommunications Initiative 2019 grant for portions of the Middlebrook area. The project would include installation of fiber to the home. Your property may or may not be in the qualifying project area, however, your input is critical to beginning the process of extending service availability to unserved areas. Responses to the following questions will be included with public input for the grant:

Do you have internet service at your location?  Yes  No

If so, are you satisfied with your service? Yes  No

Who is your current internet provider?

*A sucks*  
Viasat Internet

Thank you for taking the time to complete this short survey. Please return it in the enclosed envelope. If you are interested in completing the County's full Internet survey, go to [www.co.augusta.va.us](http://www.co.augusta.va.us) and see the survey under news and notices.

Sincerely,  
County of Augusta

COUNTY OF AUGUSTA, VA.

BOARD OF SUPERVISORS

MARSHALL W. PATTIE  
North River

GERALD W. GARBER  
Middle River

PAMELA L. CARTER  
Pastures

VACANT  
Beverley Manor

WENDELL L. COLEMAN  
Wayne

MICHAEL L. SHULL  
Riverheads

CAROLYN S. BRAGG  
South River



TIMOTHY K. FITZGERALD – COUNTY ADMINISTRATOR

AUGUSTA COUNTY GOVERNMENT CENTER

P.O. BOX 590, VERONA, VA 24482-0590

(540) 245-5610 FAX (540) 245-5621

coadmin@co.augusta.va.us

November 27, 2018

Property Owner  
Middlebrook Community

RE: Internet Survey

Dear Property Owner:

Augusta County is applying for a Virginia Telecommunications Initiative 2019 grant for portions of the Middlebrook area. The project would include installation of fiber to the home. Your property may or may not be in the qualifying project area, however, your input is critical to beginning the process of extending service availability to unserved areas. Responses to the following questions will be included with public input for the grant:

Do you have internet service at your location?

Yes  No

If so, are you satisfied with your service?

Yes  No

Who is your current internet provider?

Hughes Net

Thank you for taking the time to complete this short survey. Please return it in the enclosed envelope. If you are interested in completing the County's full Internet survey, go to [www.co.augusta.va.us](http://www.co.augusta.va.us) and see the survey under news and notices.

Sincerely,  
County of Augusta

COUNTY OF AUGUSTA, VA.

BOARD OF SUPERVISORS

MARSHALL W. PATTIE  
North River

GERALD W. GARBER  
Middle River

PAMELA L. CARTER  
Pastures

WENDELL L. COLEMAN  
Wayne

VACANT  
Beverley Manor

MICHAEL L. SHULL  
Riverheads

CAROLYN S. BRAGG  
South River



TIMOTHY K. FITZGERALD – COUNTY ADMINISTRATOR

AUGUSTA COUNTY GOVERNMENT CENTER

P.O. BOX 590, VERONA, VA 24482-0590

(540) 245-5610 FAX (540) 245-5621

coadmin@co.augusta.va.us

November 27, 2018

Property Owner  
Middlebrook Community

RE: Internet Survey

Dear Property Owner:

Augusta County is applying for a Virginia Telecommunications Initiative 2019 grant for portions of the Middlebrook area. The project would include installation of fiber to the home. Your property may or may not be in the qualifying project area, however, your input is critical to beginning the process of extending service availability to unserved areas. Responses to the following questions will be included with public input for the grant:

Do you have internet service at your location? Yes  No

If so, are you satisfied with your service? Yes  No

Who is your current internet provider? NONE

Thank you for taking the time to complete this short survey. Please return it in the enclosed envelope. If you are interested in completing the County's full Internet survey, go to [www.co.augusta.va.us](http://www.co.augusta.va.us) and see the survey under news and notices.

Sincerely,  
County of Augusta

WE WOULD VERY MUCH LIKE TO GET INTERNET!

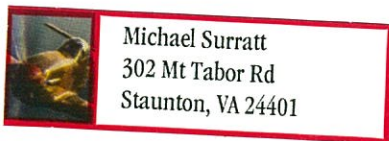



**COUNTY OF AUGUSTA, VA.**

**BOARD OF SUPERVISORS**

MARSHALL W. PATTIE  
North River

GERALD W. GARBER  
Middle River

PAMELA L. CARTER  
Pastures

WENDELL L. COLEMAN  
Wayne

VACANT  
Beverley Manor

MICHAEL L. SHULL  
Riverheads

CAROLYN S. BRAGG  
South River



**TIMOTHY K. FITZGERALD – COUNTY ADMINISTRATOR**

**AUGUSTA COUNTY GOVERNMENT CENTER**

P.O. BOX 590, VERONA, VA 24482-0590

(540) 245-5610 FAX (540) 245-5621

coadmin@co.augusta.va.us

November 27, 2018

Property Owner  
Middlebrook Community

RE: Internet Survey

Dear Property Owner:

Augusta County is applying for a Virginia Telecommunications Initiative 2019 grant for portions of the Middlebrook area. The project would include installation of fiber to the home. Your property may or may not be in the qualifying project area, however, your input is critical to beginning the process of extending service availability to unserved areas. Responses to the following questions will be included with public input for the grant:

Do you have internet service at your location?  Yes  No

If so, are you satisfied with your service? Yes  No

Who is your current internet provider? MGW

*This is awesome.  
Please bring  
fiber to Middlebrook  
we need it!*

Thank you for taking the time to complete this short survey. Please return it in the enclosed envelope. If you are interested in completing the County's full Internet survey, go to [www.co.augusta.va.us](http://www.co.augusta.va.us) and see the survey under news and notices.

Sincerely,  
County of Augusta

**COUNTY OF AUGUSTA, VA.**

**BOARD OF SUPERVISORS**

MARSHALL W. PATTIE  
North River

GERALD W. GARBER  
Middle River

PAMELA L. CARTER  
Pastures

VACANT  
Beverley Manor

WENDELL L. COLEMAN  
Wayne

MICHAEL L. SHULL  
Riverheads

CAROLYN S. BRAGG  
South River

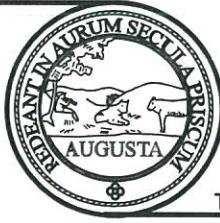

**TIMOTHY K. FITZGERALD – COUNTY ADMINISTRATOR**

**AUGUSTA COUNTY GOVERNMENT CENTER**

P.O. BOX 590, VERONA, VA 24482-0590

(540) 245-5610 FAX (540) 245-5621

coadmin@co.augusta.va.us

November 27, 2018

Property Owner  
Middlebrook Community

RE: Internet Survey

Dear Property Owner:

Augusta County is applying for a Virginia Telecommunications Initiative 2019 grant for portions of the Middlebrook area. The project would include installation of fiber to the home. Your property may or may not be in the qualifying project area, however, your input is critical to beginning the process of extending service availability to unserved areas. Responses to the following questions will be included with public input for the grant:

Do you have internet service at your location?

Yes  No

If so, are you satisfied with your service?

Yes  No

Who is your current internet provider?

NGW

Thank you for taking the time to complete this short survey. Please return it in the enclosed envelope. If you are interested in completing the County's full Internet survey, go to [www.co.augusta.va.us](http://www.co.augusta.va.us) and see the survey under news and notices.

Sincerely,  
County of Augusta

**COUNTY OF AUGUSTA, VA.**

**BOARD OF SUPERVISORS**

MARSHALL W. PATTIE  
North River

GERALD W. GARBER  
Middle River

PAMELA L. CARTER  
Pastures

WENDELL L. COLEMAN  
Wayne

VACANT  
Beverley Manor

MICHAEL L. SHULL  
Riverheads

CAROLYN S. BRAGG  
South River

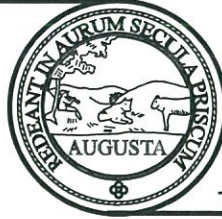

**TIMOTHY K. FITZGERALD – COUNTY ADMINISTRATOR**

**AUGUSTA COUNTY GOVERNMENT CENTER**

P.O. BOX 590, VERONA, VA 24482-0590

(540) 245-5610 FAX (540) 245-5621

coadmin@co.augusta.va.us

November 27, 2018

Property Owner  
Middlebrook Community

RE: Internet Survey

Dear Property Owner:

Augusta County is applying for a Virginia Telecommunications Initiative 2019 grant for portions of the Middlebrook area. The project would include installation of fiber to the home. Your property may or may not be in the qualifying project area, however, your input is critical to beginning the process of extending service availability to unserved areas. Responses to the following questions will be included with public input for the grant:

Do you have internet service at your location? Yes  No

If so, are you satisfied with your service? Yes  No

Who is your current internet provider? \_\_\_\_\_

Thank you for taking the time to complete this short survey. Please return it in the enclosed envelope. If you are interested in completing the County's full Internet survey, go to [www.co.augusta.va.us](http://www.co.augusta.va.us) and see the survey under news and notices.

Sincerely,  
County of Augusta

**COUNTY OF AUGUSTA, VA.**

**BOARD OF SUPERVISORS**

MARSHALL W. PATTIE  
North River

GERALD W. GARBER  
Middle River

PAMELA L. CARTER  
Pastures

WENDELL L. COLEMAN  
Wayne

VACANT  
Beverley Manor

MICHAEL L. SHULL  
Riverheads

CAROLYN S. BRAGG  
South River



**TIMOTHY K. FITZGERALD – COUNTY ADMINISTRATOR**

**AUGUSTA COUNTY GOVERNMENT CENTER**

P.O. BOX 590, VERONA, VA 24482-0590

(540) 245-5610 FAX (540) 245-5621

coadmin@co.augusta.va.us

November 27, 2018

Property Owner  
Middlebrook Community

RE: Internet Survey

Dear Property Owner:

Augusta County is applying for a Virginia Telecommunications Initiative 2019 grant for portions of the Middlebrook area. The project would include installation of fiber to the home. Your property may or may not be in the qualifying project area, however, your input is critical to beginning the process of extending service availability to unserved areas. Responses to the following questions will be included with public input for the grant:

Do you have internet service at your location? Yes No

If so, are you satisfied with your service? Yes No

Who is your current internet provider? MGW Networks

Thank you for taking the time to complete this short survey. Please return it in the enclosed envelope. If you are interested in completing the County's full Internet survey, go to [www.co.augusta.va.us](http://www.co.augusta.va.us) and see the survey under news and notices.

Sincerely,  
County of Augusta

**COUNTY OF AUGUSTA, VA.**

**BOARD OF SUPERVISORS**

MARSHALL W. PATTIE  
North River

PAMELA L. CARTER  
Pastures

MICHAEL L. SHULL  
Riverheads

VACANT  
Beverley Manor

GERALD W. GARBER  
Middle River

WENDELL L. COLEMAN  
Wayne

CAROLYN S. BRAGG  
South River



**TIMOTHY K. FITZGERALD – COUNTY ADMINISTRATOR**

**AUGUSTA COUNTY GOVERNMENT CENTER**

P.O. BOX 590, VERONA, VA 24482-0590

(540) 245-5610 FAX (540) 245-5621

coadmin@co.augusta.va.us

November 27, 2018

Property Owner  
Middlebrook Community

RE: Internet Survey

Dear Property Owner:

Augusta County is applying for a Virginia Telecommunications Initiative 2019 grant for portions of the Middlebrook area. The project would include installation of fiber to the home. Your property may or may not be in the qualifying project area, however, your input is critical to beginning the process of extending service availability to unserved areas. Responses to the following questions will be included with public input for the grant:

Do you have internet service at your location?    Yes     No

If so, are you satisfied with your service?    Yes    No

Who is your current internet provider? \_\_\_\_\_

Thank you for taking the time to complete this short survey. Please return it in the enclosed envelope. If you are interested in completing the County's full Internet survey, go to [www.co.augusta.va.us](http://www.co.augusta.va.us) and see the survey under news and notices.

Sincerely,  
County of Augusta

**COUNTY OF AUGUSTA, VA.**

**BOARD OF SUPERVISORS**

MARSHALL W. PATTIE  
North River

GERALD W. GARBER  
Middle River

PAMELA L. CARTER  
Pastures

VACANT  
Beverley Manor

WENDELL L. COLEMAN  
Wayne

MICHAEL L. SHULL  
Riverheads

CAROLYN S. BRAGG  
South River



**TIMOTHY K. FITZGERALD – COUNTY ADMINISTRATOR**

**AUGUSTA COUNTY GOVERNMENT CENTER**

P.O. BOX 590, VERONA, VA 24482-0590

(540) 245-5610 FAX (540) 245-5621

coadmin@co.augusta.va.us

November 27, 2018

Property Owner  
Middlebrook Community

RE: Internet Survey

Dear Property Owner:

Augusta County is applying for a Virginia Telecommunications Initiative 2019 grant for portions of the Middlebrook area. The project would include installation of fiber to the home. Your property may or may not be in the qualifying project area, however, your input is critical to beginning the process of extending service availability to unserved areas. Responses to the following questions will be included with public input for the grant:

Do you have internet service at your location?

Yes  No

If so, are you satisfied with your service?

Yes  No

Who is your current internet provider?

Dish

Thank you for taking the time to complete this short survey. Please return it in the enclosed envelope. If you are interested in completing the County's full Internet survey, go to [www.co.augusta.va.us](http://www.co.augusta.va.us) and see the survey under news and notices.

Sincerely,  
County of Augusta

COUNTY OF AUGUSTA, VA.

BOARD OF SUPERVISORS

MARSHALL W. PATTIE  
North River

GERALD W. GARBER  
Middle River

PAMELA L. CARTER  
Pastures

VACANT  
Beverley Manor

WENDELL L. COLEMAN  
Wayne

MICHAEL L. SHULL  
Riverheads

CAROLYN S. BRAGG  
South River



TIMOTHY K. FITZGERALD – COUNTY ADMINISTRATOR

AUGUSTA COUNTY GOVERNMENT CENTER

P.O. BOX 590, VERONA, VA 24482-0590

(540) 245-5610 FAX (540) 245-5621

coadmin@co.augusta.va.us

November 27, 2018

Property Owner  
Middlebrook Community

RE: Internet Survey

Dear Property Owner:

Augusta County is applying for a Virginia Telecommunications Initiative 2019 grant for portions of the Middlebrook area. The project would include installation of fiber to the home. Your property may or may not be in the qualifying project area, however, your input is critical to beginning the process of extending service availability to unserved areas. Responses to the following questions will be included with public input for the grant:

Do you have internet service at your location?  Yes  No

If so, are you satisfied with your service? Yes  No *Its awful*

Who is your current internet provider? Verizon

Thank you for taking the time to complete this short survey. Please return it in the enclosed envelope. If you are interested in completing the County's full Internet survey, go to [www.co.augusta.va.us](http://www.co.augusta.va.us) and see the survey under news and notices.

Sincerely,  
County of Augusta

**COUNTY OF AUGUSTA, VA.**

**BOARD OF SUPERVISORS**

MARSHALL W. PATTIE  
North River

GERALD W. GARBER  
Middle River

PAMELA L. CARTER  
Pastures

VACANT  
Beverly Manor

WENDELL L. COLEMAN  
Wayne

MICHAEL L. SHULL  
Riverheads

CAROLYN S. BRAGG  
South River

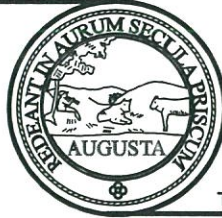

**TIMOTHY K. FITZGERALD – COUNTY ADMINISTRATOR**

**AUGUSTA COUNTY GOVERNMENT CENTER**

P.O. BOX 590, VERONA, VA 24482-0590

(540) 245-5610 FAX (540) 245-5621

coadmin@co.augusta.va.us

November 27, 2018

Property Owner  
Middlebrook Community

RE: Internet Survey

Dear Property Owner:

Augusta County is applying for a Virginia Telecommunications Initiative 2019 grant for portions of the Middlebrook area. The project would include installation of fiber to the home. Your property may or may not be in the qualifying project area, however, your input is critical to beginning the process of extending service availability to unserved areas. Responses to the following questions will be included with public input for the grant:

Do you have internet service at your location?    Yes    No

If so, are you satisfied with your service?    Yes    No

Who is your current internet provider? \_\_\_\_\_

Thank you for taking the time to complete this short survey. Please return it in the enclosed envelope. If you are interested in completing the County's full Internet survey, go to [www.co.augusta.va.us](http://www.co.augusta.va.us) and see the survey under news and notices.

Sincerely,  
County of Augusta



**COUNTY OF AUGUSTA, VA.**

**BOARD OF SUPERVISORS**

MARSHALL W. PATTIE  
North River

GERALD W. GARBER  
Middle River

PAMELA L. CARTER  
Pastures

VACANT  
Beverly Manor

WENDELL L. COLEMAN  
Wayne

MICHAEL L. SHULL  
Riverheads

CAROLYN S. BRAGG  
South River



**TIMOTHY K. FITZGERALD – COUNTY ADMINISTRATOR**

**AUGUSTA COUNTY GOVERNMENT CENTER**

P.O. BOX 590, VERONA, VA 24482-0590

(540) 245-5610 FAX (540) 245-5621

coadmin@co.augusta.va.us

November 27, 2018

Property Owner  
Middlebrook Community

RE: Internet Survey

Dear Property Owner:

Augusta County is applying for a Virginia Telecommunications Initiative 2019 grant for portions of the Middlebrook area. The project would include installation of fiber to the home. Your property may or may not be in the qualifying project area, however, your input is critical to beginning the process of extending service availability to unserved areas. Responses to the following questions will be included with public input for the grant:

Do you have internet service at your location?    Yes     No

If so, are you satisfied with your service?    Yes    No

Who is your current internet provider? \_\_\_\_\_

Thank you for taking the time to complete this short survey. Please return it in the enclosed envelope. If you are interested in completing the County's full Internet survey, go to [www.co.augusta.va.us](http://www.co.augusta.va.us) and see the survey under news and notices.

Sincerely,  
County of Augusta

**COUNTY OF AUGUSTA, VA.**

**BOARD OF SUPERVISORS**

MARSHALL W. PATTIE  
North River

PAMELA L. CARTER  
Pastures

MICHAEL L. SHULL  
Riverheads

GERALD W. GARBER  
Middle River

WENDELL L. COLEMAN  
Wayne

CAROLYN S. BRAGG  
South River



**TIMOTHY K. FITZGERALD – COUNTY ADMINISTRATOR**

**AUGUSTA COUNTY GOVERNMENT CENTER**

P.O. BOX 590, VERONA, VA 24482-0590

(540) 245-5610 FAX (540) 245-5621

coadmin@co.augusta.va.us

November 27, 2018

Property Owner  
Middlebrook Community

RE: Internet Survey

Dear Property Owner:

Augusta County is applying for a Virginia Telecommunications Initiative 2019 grant for portions of the Middlebrook area. The project would include installation of fiber to the home. Your property may or may not be in the qualifying project area, however, your input is critical to beginning the process of extending service availability to unserved areas. Responses to the following questions will be included with public input for the grant:

Do you have internet service at your location?    Yes     No

If so, are you satisfied with your service?    Yes    No

Who is your current internet provider? \_\_\_\_\_

Thank you for taking the time to complete this short survey. Please return it in the enclosed envelope. If you are interested in completing the County's full Internet survey, go to [www.co.augusta.va.us](http://www.co.augusta.va.us) and see the survey under news and notices.

Sincerely,  
County of Augusta

COUNTY OF AUGUSTA, VA.

BOARD OF SUPERVISORS

MARSHALL W. PATTIE  
North River

GERALD W. GARBER  
Middle River

PAMELA L. CARTER  
Pastures

WENDELL L. COLEMAN  
Wayne

VACANT  
Beverley Manor

MICHAEL L. SHULL  
Riverheads

CAROLYN S. BRAGG  
South River



TIMOTHY K. FITZGERALD – COUNTY ADMINISTRATOR

AUGUSTA COUNTY GOVERNMENT CENTER

P.O. BOX 590, VERONA, VA 24482-0590

(540) 245-5610 FAX (540) 245-5621

coadmin@co.augusta.va.us

November 27, 2018

Property Owner  
Middlebrook Community

RE: Internet Survey

Dear Property Owner:

Augusta County is applying for a Virginia Telecommunications Initiative 2019 grant for portions of the Middlebrook area. The project would include installation of fiber to the home. Your property may or may not be in the qualifying project area, however, your input is critical to beginning the process of extending service availability to unserved areas. Responses to the following questions will be included with public input for the grant:

Do you have internet service at your location?

Yes  No

If so, are you satisfied with your service?

Yes  No

Who is your current internet provider?

Verizon through phone

Thank you for taking the time to complete this short survey. Please return it in the enclosed envelope. If you are interested in completing the County's full Internet survey, go to [www.co.augusta.va.us](http://www.co.augusta.va.us) and see the survey under news and notices.

Sincerely,  
County of Augusta

~~Dear~~

Hello,  
We currently use Verizon as <sup>our</sup> internet provider, However it barely works,  
We are in need of a better provider. A good provider is needed  
in the area. We barely get phone service.

**COUNTY OF AUGUSTA, VA.**

**BOARD OF SUPERVISORS**

MARSHALL W. PATTIE  
North River

GERALD W. GARBER  
Middle River

PAMELA L. CARTER  
Pastures

VACANT  
Beverley Manor

WENDELL L. COLEMAN  
Wayne

MICHAEL L. SHULL  
Riverheads

CAROLYN S. BRAGG  
South River



**TIMOTHY K. FITZGERALD – COUNTY ADMINISTRATOR**

**AUGUSTA COUNTY GOVERNMENT CENTER**

P.O. BOX 590, VERONA, VA 24482-0590

(540) 245-5610 FAX (540) 245-5621

coadmin@co.augusta.va.us

November 27, 2018

Property Owner  
Middlebrook Community

RE: Internet Survey

Dear Property Owner:

Augusta County is applying for a Virginia Telecommunications Initiative 2019 grant for portions of the Middlebrook area. The project would include installation of fiber to the home. Your property may or may not be in the qualifying project area, however, your input is critical to beginning the process of extending service availability to unserved areas. Responses to the following questions will be included with public input for the grant:

Do you have internet service at your location?    Yes    No

If so, are you satisfied with your service?    Yes    No

Who is your current internet provider?    NONE

Thank you for taking the time to complete this short survey. Please return it in the enclosed envelope. If you are interested in completing the County's full Internet survey, go to [www.co.augusta.va.us](http://www.co.augusta.va.us) and see the survey under news and notices.

Sincerely,  
County of Augusta

COUNTY OF AUGUSTA, VA.

BOARD OF SUPERVISORS

MARSHALL W. PATTIE  
North River

GERALD W. GARBER  
Middle River

PAMELA L. CARTER  
Pastures

VACANT  
Beverley Manor

WENDELL L. COLEMAN  
Wayne

MICHAEL L. SHULL  
Riverheads

CAROLYN S. BRAGG  
South River

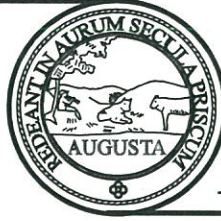

TIMOTHY K. FITZGERALD – COUNTY ADMINISTRATOR

AUGUSTA COUNTY GOVERNMENT CENTER

P.O. BOX 590, VERONA, VA 24482-0590

(540) 245-5610 FAX (540) 245-5621

coadmin@co.augusta.va.us

November 27, 2018

Property Owner  
Middlebrook Community

RE: Internet Survey

Dear Property Owner:

Augusta County is applying for a Virginia Telecommunications Initiative 2019 grant for portions of the Middlebrook area. The project would include installation of fiber to the home. Your property may or may not be in the qualifying project area, however, your input is critical to beginning the process of extending service availability to unserved areas. Responses to the following questions will be included with public input for the grant:

Do you have internet service at your location? Yes

No

If so, are you satisfied with your service? Yes

No

Who is your current internet provider?

*none available other than sporadic  
cellphone access via Verizon wireless*

Thank you for taking the time to complete this short survey. Please return it in the enclosed envelope. If you are interested in completing the County's full Internet survey, go to [www.co.augusta.va.us](http://www.co.augusta.va.us) and see the survey under news and notices.

Sincerely,  
County of Augusta

**COUNTY OF AUGUSTA, VA.**

**BOARD OF SUPERVISORS**

MARSHALL W. PATTIE  
North River

GERALD W. GARBER  
Middle River

PAMELA L. CARTER  
Pastures

VACANT  
Beverley Manor

WENDELL L. COLEMAN  
Wayne

MICHAEL L. SHULL  
Riverheads

CAROLYN S. BRAGG  
South River



**TIMOTHY K. FITZGERALD – COUNTY ADMINISTRATOR**

**AUGUSTA COUNTY GOVERNMENT CENTER**

P.O. BOX 590, VERONA, VA 24482-0590

(540) 245-5610 FAX (540) 245-5621

coadmin@co.augusta.va.us

November 27, 2018

Property Owner  
Middlebrook Community

RE: Internet Survey

Dear Property Owner:

Augusta County is applying for a Virginia Telecommunications Initiative 2019 grant for portions of the Middlebrook area. The project would include installation of fiber to the home. Your property may or may not be in the qualifying project area, however, your input is critical to beginning the process of extending service availability to unserved areas. Responses to the following questions will be included with public input for the grant:

Do you have internet service at your location?    Yes    No

If so, are you satisfied with your service?    Yes    No

Who is your current internet provider? \_\_\_\_\_

Thank you for taking the time to complete this short survey. Please return it in the enclosed envelope. If you are interested in completing the County's full Internet survey, go to [www.co.augusta.va.us](http://www.co.augusta.va.us) and see the survey under news and notices.

Sincerely,  
County of Augusta

COUNTY OF AUGUSTA, VA.

BOARD OF SUPERVISORS

MARSHALL W. PATTIE  
North River

GERALD W. GARBER  
Middle River

PAMELA L. CARTER  
Pastures

WENDELL L. COLEMAN  
Wayne

VACANT  
Beverley Manor

MICHAEL L. SHULL  
Riverheads

CAROLYN S. BRAGG  
South River



TIMOTHY K. FITZGERALD – COUNTY ADMINISTRATOR

AUGUSTA COUNTY GOVERNMENT CENTER

P.O. BOX 590, VERONA, VA 24482-0590

(540) 245-5610 FAX (540) 245-5621

coadmin@co.augusta.va.us

November 27, 2018

Property Owner  
Middlebrook Community

RE: Internet Survey

Dear Property Owner:

Augusta County is applying for a Virginia Telecommunications Initiative 2019 grant for portions of the Middlebrook area. The project would include installation of fiber to the home. Your property may or may not be in the qualifying project area, however, your input is critical to beginning the process of extending service availability to unserved areas. Responses to the following questions will be included with public input for the grant:

Do you have internet service at your location? Yes  No

If so, are you satisfied with your service? Yes  No

Who is your current internet provider? \_\_\_\_\_

Thank you for taking the time to complete this short survey. Please return it in the enclosed envelope. If you are interested in completing the County's full Internet survey, go to [www.co.augusta.va.us](http://www.co.augusta.va.us) and see the survey under news and notices.

Sincerely,  
County of Augusta

*Would be very interested in a reliable, cost efficient internet service*

*Helin R. Payne  
245 Mt Tabor Rd  
Staunton, Virginia 24401  
(540) 886-3733*

**COUNTY OF AUGUSTA, VA.**

**BOARD OF SUPERVISORS**

MARSHALL W. PATTIE  
North River

GERALD W. GARBER  
Middle River

PAMELA L. CARTER  
Pastures

WENDELL L. COLEMAN  
Wayne

VACANT  
Beverly Manor

MICHAEL L. SHULL  
Riverheads

CAROLYN S. BRAGG  
South River



**TIMOTHY K. FITZGERALD – COUNTY ADMINISTRATOR**

**AUGUSTA COUNTY GOVERNMENT CENTER**

P.O. BOX 590, VERONA, VA 24482-0590

(540) 245-5610 FAX (540) 245-5621

coadmin@co.augusta.va.us

November 27, 2018

Property Owner  
Middlebrook Community

RE: Internet Survey

Dear Property Owner:

Augusta County is applying for a Virginia Telecommunications Initiative 2019 grant for portions of the Middlebrook area. The project would include installation of fiber to the home. Your property may or may not be in the qualifying project area, however, your input is critical to beginning the process of extending service availability to unserved areas. Responses to the following questions will be included with public input for the grant:

Do you have internet service at your location?  Yes  No

If so, are you satisfied with your service? Yes  No

Who is your current internet provider? MGW

Thank you for taking the time to complete this short survey. Please return it in the enclosed envelope. If you are interested in completing the County's full Internet survey, go to [www.co.augusta.va.us](http://www.co.augusta.va.us) and see the survey under news and notices.

Sincerely,  
County of Augusta



**COUNTY OF AUGUSTA, VA.**

**BOARD OF SUPERVISORS**

MARSHALL W. PATTIE  
North River

PAMELA L. CARTER  
Pastures

MICHAEL L. SHULL  
Riverheads

VACANT  
Beverley Manor

GERALD W. GARBER  
Middle River

WENDELL L. COLEMAN  
Wayne

CAROLYN S. BRAGG  
South River



**TIMOTHY K. FITZGERALD – COUNTY ADMINISTRATOR**

**AUGUSTA COUNTY GOVERNMENT CENTER**

P.O. BOX 590, VERONA, VA 24482-0590

(540) 245-5610 FAX (540) 245-5621

coadmin@co.augusta.va.us

November 27, 2018

Property Owner  
Middlebrook Community

RE: Internet Survey

Dear Property Owner:

Augusta County is applying for a Virginia Telecommunications Initiative 2019 grant for portions of the Middlebrook area. The project would include installation of fiber to the home. Your property may or may not be in the qualifying project area, however, your input is critical to beginning the process of extending service availability to unserved areas. Responses to the following questions will be included with public input for the grant:

Do you have internet service at your location?

Yes  No

If so, are you satisfied with your service?

Yes  No

Who is your current internet provider?

MGW

Thank you for taking the time to complete this short survey. Please return it in the enclosed envelope. If you are interested in completing the County's full Internet survey, go to [www.co.augusta.va.us](http://www.co.augusta.va.us) and see the survey under news and notices.

Sincerely,  
County of Augusta

**COUNTY OF AUGUSTA, VA.**

**BOARD OF SUPERVISORS**

MARSHALL W. PATTIE  
North River

GERALD W. GARBER  
Middle River

PAMELA L. CARTER  
Pastures

WENDELL L. COLEMAN  
Wayne

VACANT  
Beverly Manor

MICHAEL L. SHULL  
Riverheads

CAROLYN S. BRAGG  
South River



**TIMOTHY K. FITZGERALD – COUNTY ADMINISTRATOR**

**AUGUSTA COUNTY GOVERNMENT CENTER**

P.O. BOX 590, VERONA, VA 24482-0590

(540) 245-5610 FAX (540) 245-5621

coadmin@co.augusta.va.us

November 27, 2018

Property Owner  
Middlebrook Community

RE: Internet Survey

Dear Property Owner:

Augusta County is applying for a Virginia Telecommunications Initiative 2019 grant for portions of the Middlebrook area. The project would include installation of fiber to the home. Your property may or may not be in the qualifying project area, however, your input is critical to beginning the process of extending service availability to unserved areas. Responses to the following questions will be included with public input for the grant:

Do you have internet service at your location?  Yes  No

If so, are you satisfied with your service? Yes  No

Who is your current internet provider? VERIZON

Thank you for taking the time to complete this short survey. Please return it in the enclosed envelope. If you are interested in completing the County's full Internet survey, go to [www.co.augusta.va.us](http://www.co.augusta.va.us) and see the survey under news and notices.

Sincerely,  
County of Augusta

COUNTY OF AUGUSTA, VA.

BOARD OF SUPERVISORS

MARSHALL W. PATTIE  
North River

GERALD W. GARBER  
Middle River

PAMELA L. CARTER  
Pastures

WENDELL L. COLEMAN  
Wayne

VACANT  
Beverley Manor

MICHAEL L. SHULL  
Riverheads

CAROLYN S. BRAGG  
South River

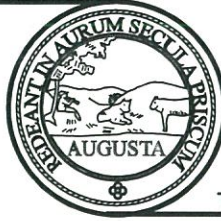

TIMOTHY K. FITZGERALD – COUNTY ADMINISTRATOR

AUGUSTA COUNTY GOVERNMENT CENTER

P.O. BOX 590, VERONA, VA 24482-0590

(540) 245-5610 FAX (540) 245-5621

coadmin@co.augusta.va.us

November 27, 2018

Property Owner  
Middlebrook Community

RE: Internet Survey

Dear Property Owner:

Augusta County is applying for a Virginia Telecommunications Initiative 2019 grant for portions of the Middlebrook area. The project would include installation of fiber to the home. Your property may or may not be in the qualifying project area, however, your input is critical to beginning the process of extending service availability to unserved areas. Responses to the following questions will be included with public input for the grant:

Do you have internet service at your location?

Yes

No

If so, are you satisfied with your service?

Yes

No

Who is your current internet provider?

M&W/Lingo Networks

*I would be very interested in this service if available*  
*Ann E Herza*

Thank you for taking the time to complete this short survey. Please return it in the enclosed envelope. If you are interested in completing the County's full Internet survey, go to [www.co.augusta.va.us](http://www.co.augusta.va.us) and see the survey under news and notices.

Sincerely,  
County of Augusta

**COUNTY OF AUGUSTA, VA.**

**BOARD OF SUPERVISORS**

MARSHALL W. PATTIE  
North River

PAMELA L. CARTER  
Pastures

MICHAEL L. SHULL  
Riverheads

VACANT  
Beverley Manor

GERALD W. GARBER  
Middle River

WENDELL L. COLEMAN  
Wayne

CAROLYN S. BRAGG  
South River

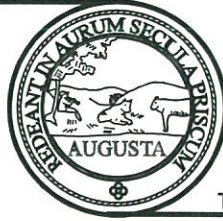

**TIMOTHY K. FITZGERALD – COUNTY ADMINISTRATOR**

**AUGUSTA COUNTY GOVERNMENT CENTER**

P.O. BOX 590, VERONA, VA 24482-0590

(540) 245-5610 FAX (540) 245-5621

coadmin@co.augusta.va.us

November 27, 2018

Property Owner  
Middlebrook Community

RE: Internet Survey

Dear Property Owner:

Augusta County is applying for a Virginia Telecommunications Initiative 2019 grant for portions of the Middlebrook area. The project would include installation of fiber to the home. Your property may or may not be in the qualifying project area, however, your input is critical to beginning the process of extending service availability to unserved areas. Responses to the following questions will be included with public input for the grant:

Do you have internet service at your location?  Yes  No

If so, are you satisfied with your service? Yes  No

Who is your current internet provider? Verizon

Thank you for taking the time to complete this short survey. Please return it in the enclosed envelope. If you are interested in completing the County's full Internet survey, go to [www.co.augusta.va.us](http://www.co.augusta.va.us) and see the survey under news and notices.

Sincerely,  
County of Augusta

**COUNTY OF AUGUSTA, VA.**

**BOARD OF SUPERVISORS**

MARSHALL W. PATTIE  
North River

GERALD W. GARBER  
Middle River

PAMELA L. CARTER  
Pastures

WENDELL L. COLEMAN  
Wayne

MICHAEL L. SHULL  
Riverheads

VACANT  
Beverley Manor

CAROLYN S. BRAGG  
South River



**TIMOTHY K. FITZGERALD – COUNTY ADMINISTRATOR**

**AUGUSTA COUNTY GOVERNMENT CENTER**

P.O. BOX 590, VERONA, VA 24482-0590

(540) 245-5610 FAX (540) 245-5621

coadmin@co.augusta.va.us

November 27, 2018

Property Owner  
Middlebrook Community

RE: Internet Survey

Dear Property Owner:

Augusta County is applying for a Virginia Telecommunications Initiative 2019 grant for portions of the Middlebrook area. The project would include installation of fiber to the home. Your property may or may not be in the qualifying project area, however, your input is critical to beginning the process of extending service availability to unserved areas. Responses to the following questions will be included with public input for the grant:

Do you have internet service at your location?    Yes     No

If so, are you satisfied with your service?    Yes    No

Who is your current internet provider?    \_\_\_\_\_

Thank you for taking the time to complete this short survey. Please return it in the enclosed envelope. If you are interested in completing the County's full Internet survey, go to [www.co.augusta.va.us](http://www.co.augusta.va.us) and see the survey under news and notices.

Sincerely,  
County of Augusta

**COUNTY OF AUGUSTA, VA.**

**BOARD OF SUPERVISORS**

MARSHALL W. PATTIE  
North River

GERALD W. GARBER  
Middle River

PAMELA L. CARTER  
Pastures

VACANT  
Beverley Manor

WENDELL L. COLEMAN  
Wayne

MICHAEL L. SHULL  
Riverheads

CAROLYN S. BRAGG  
South River

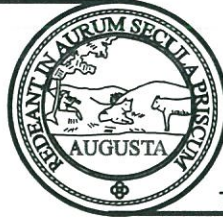

**TIMOTHY K. FITZGERALD – COUNTY ADMINISTRATOR**

**AUGUSTA COUNTY GOVERNMENT CENTER**

P.O. BOX 590, VERONA, VA 24482-0590

(540) 245-5610 FAX (540) 245-5621

coadmin@co.augusta.va.us

November 27, 2018

Property Owner  
Middlebrook Community

RE: Internet Survey

Dear Property Owner:

Augusta County is applying for a Virginia Telecommunications Initiative 2019 grant for portions of the Middlebrook area. The project would include installation of fiber to the home. Your property may or may not be in the qualifying project area, however, your input is critical to beginning the process of extending service availability to unserved areas. Responses to the following questions will be included with public input for the grant:

Do you have internet service at your location?  Yes  No

If so, are you satisfied with your service?  Yes  No

Who is your current internet provider?

Verizon

Thank you for taking the time to complete this short survey. Please return it in the enclosed envelope. If you are interested in completing the County's full Internet survey, go to [www.co.augusta.va.us](http://www.co.augusta.va.us) and see the survey under news and notices.

Sincerely,  
County of Augusta

**COUNTY OF AUGUSTA, VA.**

**BOARD OF SUPERVISORS**

MARSHALL W. PATTIE  
North River

GERALD W. GARBER  
Middle River

PAMELA L. CARTER  
Pastures

VACANT  
Beverley Manor

WENDELL L. COLEMAN  
Wayne

MICHAEL L. SHULL  
Riverheads

CAROLYN S. BRAGG  
South River



**TIMOTHY K. FITZGERALD – COUNTY ADMINISTRATOR**

**AUGUSTA COUNTY GOVERNMENT CENTER**

P.O. BOX 590, VERONA, VA 24482-0590

(540) 245-5610 FAX (540) 245-5621

coadmin@co.augusta.va.us

November 27, 2018

Property Owner  
Middlebrook Community

RE: Internet Survey

Dear Property Owner:

Augusta County is applying for a Virginia Telecommunications Initiative 2019 grant for portions of the Middlebrook area. The project would include installation of fiber to the home. Your property may or may not be in the qualifying project area, however, your input is critical to beginning the process of extending service availability to unserved areas. Responses to the following questions will be included with public input for the grant:

Do you have internet service at your location?  Yes  No

If so, are you satisfied with your service?  Yes  No

Who is your current internet provider? Verizon WiFi

Thank you for taking the time to complete this short survey. Please return it in the enclosed envelope. If you are interested in completing the County's full Internet survey, go to [www.co.augusta.va.us](http://www.co.augusta.va.us) and see the survey under news and notices.

Sincerely,  
County of Augusta

COUNTY OF AUGUSTA, VA.

BOARD OF SUPERVISORS

MARSHALL W. PATTIE  
North River

GERALD W. GARBER  
Middle River

PAMELA L. CARTER  
Pastures

WENDELL L. COLEMAN  
Wayne

VACANT  
Beverley Manor

MICHAEL L. SHULL  
Riverheads

CAROLYN S. BRAGG  
South River



TIMOTHY K. FITZGERALD – COUNTY ADMINISTRATOR

AUGUSTA COUNTY GOVERNMENT CENTER

P.O. BOX 590, VERONA, VA 24482-0590

(540) 245-5610 FAX (540) 245-5621

coadmin@co.augusta.va.us

November 27, 2018

Property Owner  
Middlebrook Community

RE: Internet Survey

Dear Property Owner:

Augusta County is applying for a Virginia Telecommunications Initiative 2019 grant for portions of the Middlebrook area. The project would include installation of fiber to the home. Your property may or may not be in the qualifying project area, however, your input is critical to beginning the process of extending service availability to unserved areas. Responses to the following questions will be included with public input for the grant:

Do you have internet service at your location?  Yes  No

If so, are you satisfied with your service? Yes  No

Who is your current internet provider?

*Hughes — not sufficient to stream or work from home*

Thank you for taking the time to complete this short survey. Please return it in the enclosed envelope. If you are interested in completing the County's full Internet survey, go to [www.co.augusta.va.us](http://www.co.augusta.va.us) and see the survey under news and notices.

Sincerely,  
County of Augusta



**COUNTY OF AUGUSTA, VA.**

**BOARD OF SUPERVISORS**

MARSHALL W. PATTIE  
North River

GERALD W. GARBER  
Middle River

PAMELA L. CARTER  
Pastures

VACANT  
Beverly Manor

WENDELL L. COLEMAN  
Wayne

MICHAEL L. SHULL  
Riverheads

CAROLYN S. BRAGG  
South River

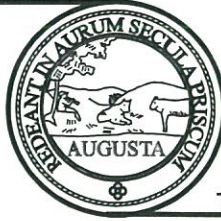

**TIMOTHY K. FITZGERALD – COUNTY ADMINISTRATOR**

**AUGUSTA COUNTY GOVERNMENT CENTER**

P.O. BOX 590, VERONA, VA 24482-0590

(540) 245-5610 FAX (540) 245-5621

coadmin@co.augusta.va.us

November 27, 2018

Property Owner  
Middlebrook Community

RE: Internet Survey

Dear Property Owner:

Augusta County is applying for a Virginia Telecommunications Initiative 2019 grant for portions of the Middlebrook area. The project would include installation of fiber to the home. Your property may or may not be in the qualifying project area, however, your input is critical to beginning the process of extending service availability to unserved areas. Responses to the following questions will be included with public input for the grant:

Do you have internet service at your location?  Yes  No

If so, are you satisfied with your service? Yes  No (very)

Who is your current internet provider? exceed

Thank you for taking the time to complete this short survey. Please return it in the enclosed envelope. If you are interested in completing the County's full Internet survey, go to [www.co.augusta.va.us](http://www.co.augusta.va.us) and see the survey under news and notices.

Sincerely,  
County of Augusta

**COUNTY OF AUGUSTA, VA.**

**BOARD OF SUPERVISORS**

MARSHALL W. PATTIE  
North River

GERALD W. GARBER  
Middle River

PAMELA L. CARTER  
Pastures

VACANT  
Beverley Manor

WENDELL L. COLEMAN  
Wayne

MICHAEL L. SHULL  
Riverheads

CAROLYN S. BRAGG  
South River



**TIMOTHY K. FITZGERALD – COUNTY ADMINISTRATOR**

**AUGUSTA COUNTY GOVERNMENT CENTER**

P.O. BOX 590, VERONA, VA 24482-0590

(540) 245-5610 FAX (540) 245-5621

coadmin@co.augusta.va.us

November 27, 2018

Property Owner  
Middlebrook Community

RE: Internet Survey

Dear Property Owner:

Augusta County is applying for a Virginia Telecommunications Initiative 2019 grant for portions of the Middlebrook area. The project would include installation of fiber to the home. Your property may or may not be in the qualifying project area, however, your input is critical to beginning the process of extending service availability to unserved areas. Responses to the following questions will be included with public input for the grant:

Do you have internet service at your location?

Yes No

If so, are you satisfied with your service?

Yes No

Who is your current internet provider?

Verizon

Thank you for taking the time to complete this short survey. Please return it in the enclosed envelope. If you are interested in completing the County's full Internet survey, go to [www.co.augusta.va.us](http://www.co.augusta.va.us) and see the survey under news and notices.

Sincerely,  
County of Augusta

COUNTY OF AUGUSTA, VA.

BOARD OF SUPERVISORS

MARSHALL W. PATTIE  
North River

GERALD W. GARBER  
Middle River

PAMELA L. CARTER  
Pastures

VACANT  
Beverley Manor

WENDELL L. COLEMAN  
Wayne

MICHAEL L. SHULL  
Riverheads

CAROLYN S. BRAGG  
South River



TIMOTHY K. FITZGERALD – COUNTY ADMINISTRATOR

AUGUSTA COUNTY GOVERNMENT CENTER

P.O. BOX 590, VERONA, VA 24482-0590

(540) 245-5610 FAX (540) 245-5621

coadmin@co.augusta.va.us

November 27, 2018

Property Owner  
Middlebrook Community

RE: Internet Survey

Dear Property Owner:

Augusta County is applying for a Virginia Telecommunications Initiative 2019 grant for portions of the Middlebrook area. The project would include installation of fiber to the home. Your property may or may not be in the qualifying project area, however, your input is critical to beginning the process of extending service availability to unserved areas. Responses to the following questions will be included with public input for the grant:

Do you have internet service at your location?  Yes  No

If so, are you satisfied with your service?  Yes  No

Who is your current internet provider?

Verizon Wireless (cell phone hotspots)

Thank you for taking the time to complete this short survey. Please return it in the enclosed envelope. If you are interested in completing the County's full Internet survey, go to [www.co.augusta.va.us](http://www.co.augusta.va.us) and see the survey under news and notices.

Sincerely,  
County of Augusta

COUNTY OF AUGUSTA, VA.

BOARD OF SUPERVISORS

MARSHALL W. PATTIE  
North River

GERALD W. GARBER  
Middle River

PAMELA L. CARTER  
Pastures

WENDELL L. COLEMAN  
Wayne

VACANT  
Beverley Manor

MICHAEL L. SHULL  
Riverheads

CAROLYN S. BRAGG  
South River



TIMOTHY K. FITZGERALD – COUNTY ADMINISTRATOR

AUGUSTA COUNTY GOVERNMENT CENTER

P.O. BOX 590, VERONA, VA 24482-0590

(540) 245-5610 FAX (540) 245-5621

coadmin@co.augusta.va.us

November 27, 2018

Property Owner  
Middlebrook Community

RE: Internet Survey

Dear Property Owner:

Augusta County is applying for a Virginia Telecommunications Initiative 2019 grant for portions of the Middlebrook area. The project would include installation of fiber to the home. Your property may or may not be in the qualifying project area, however, your input is critical to beginning the process of extending service availability to unserved areas. Responses to the following questions will be included with public input for the grant:

Do you have internet service at your location?

Yes     No    *Poor & Slow*

If so, are you satisfied with your service?

Yes     No

Who is your current internet provider?

Verizon

Thank you for taking the time to complete this short survey. Please return it in the enclosed envelope. If you are interested in completing the County's full Internet survey, go to [www.co.augusta.va.us](http://www.co.augusta.va.us) and see the survey under news and notices.

Sincerely,  
County of Augusta

*Note: we live on Ababail Road*

**COUNTY OF AUGUSTA, VA.**

**BOARD OF SUPERVISORS**

MARSHALL W. PATTIE  
North River

GERALD W. GARBER  
Middle River

PAMELA L. CARTER  
Pastures

VACANT  
Beverley Manor

WENDELL L. COLEMAN  
Wayne

MICHAEL L. SHULL  
Riverheads

CAROLYN S. BRAGG  
South River



**TIMOTHY K. FITZGERALD – COUNTY ADMINISTRATOR**

**AUGUSTA COUNTY GOVERNMENT CENTER**

P.O. BOX 590, VERONA, VA 24482-0590

(540) 245-5610 FAX (540) 245-5621

coadmin@co.augusta.va.us

November 27, 2018

Property Owner  
Middlebrook Community

RE: Internet Survey

Dear Property Owner:

Augusta County is applying for a Virginia Telecommunications Initiative 2019 grant for portions of the Middlebrook area. The project would include installation of fiber to the home. Your property may or may not be in the qualifying project area, however, your input is critical to beginning the process of extending service availability to unserved areas. Responses to the following questions will be included with public input for the grant:

Do you have internet service at your location?  Yes  No

If so, are you satisfied with your service? Yes  No

Who is your current internet provider? Verizon

Thank you for taking the time to complete this short survey. Please return it in the enclosed envelope. If you are interested in completing the County's full Internet survey, go to [www.co.augusta.va.us](http://www.co.augusta.va.us) and see the survey under news and notices.

Sincerely,  
County of Augusta

**COUNTY OF AUGUSTA, VA.**

**BOARD OF SUPERVISORS**

MARSHALL W. PATTIE  
North River

PAMELA L. CARTER  
Pastures

MICHAEL L. SHULL  
Riverheads

VACANT  
Beverley Manor

GERALD W. GARBER  
Middle River

WENDELL L. COLEMAN  
Wayne

CAROLYN S. BRAGG  
South River



**TIMOTHY K. FITZGERALD – COUNTY ADMINISTRATOR**

**AUGUSTA COUNTY GOVERNMENT CENTER**

P.O. BOX 590, VERONA, VA 24482-0590

(540) 245-5610 FAX (540) 245-5621

coadmin@co.augusta.va.us

November 27, 2018

Property Owner  
Middlebrook Community

RE: Internet Survey

Dear Property Owner:

Augusta County is applying for a Virginia Telecommunications Initiative 2019 grant for portions of the Middlebrook area. The project would include installation of fiber to the home. Your property may or may not be in the qualifying project area, however, your input is critical to beginning the process of extending service availability to unserved areas. Responses to the following questions will be included with public input for the grant:

Do you have internet service at your location?  Yes  No

If so, are you satisfied with your service?  Yes  No

Who is your current internet provider? Hughes Net

Thank you for taking the time to complete this short survey. Please return it in the enclosed envelope. If you are interested in completing the County's full Internet survey, go to [www.co.augusta.va.us](http://www.co.augusta.va.us) and see the survey under news and notices.

Sincerely,  
County of Augusta

COUNTY OF AUGUSTA, VA.

BOARD OF SUPERVISORS

MARSHALL W. PATTIE  
North River

GERALD W. GARBER  
Middle River

PAMELA L. CARTER  
Pastures

WENDELL L. COLEMAN  
Wayne

VACANT  
Beverley Manor

MICHAEL L. SHULL  
Riverheads

CAROLYN S. BRAGG  
South River



TIMOTHY K. FITZGERALD – COUNTY ADMINISTRATOR

AUGUSTA COUNTY GOVERNMENT CENTER

P.O. BOX 590, VERONA, VA 24482-0590

(540) 245-5610 FAX (540) 245-5621

coadmin@co.augusta.va.us

November 27, 2018

Property Owner  
Middlebrook Community

RE: Internet Survey

Dear Property Owner:

Augusta County is applying for a Virginia Telecommunications Initiative 2019 grant for portions of the Middlebrook area. The project would include installation of fiber to the home. Your property may or may not be in the qualifying project area, however, your input is critical to beginning the process of extending service availability to unserved areas. Responses to the following questions will be included with public input for the grant:

Do you have internet service at your location?  Yes  No

If so, are you satisfied with your service? Yes  No

Who is your current internet provider?

Hughes Net Satellite (Slow)

Thank you for taking the time to complete this short survey. Please return it in the enclosed envelope. If you are interested in completing the County's full Internet survey, go to [www.co.augusta.va.us](http://www.co.augusta.va.us) and see the survey under news and notices.

Sincerely,  
County of Augusta

**COUNTY OF AUGUSTA, VA.**

**BOARD OF SUPERVISORS**

MARSHALL W. PATTIE  
North River

GERALD W. GARBER  
Middle River

PAMELA L. CARTER  
Pastures

VACANT  
Beverley Manor

WENDELL L. COLEMAN  
Wayne

MICHAEL L. SHULL  
Riverheads

CAROLYN S. BRAGG  
South River



**TIMOTHY K. FITZGERALD – COUNTY ADMINISTRATOR**

**AUGUSTA COUNTY GOVERNMENT CENTER**

P.O. BOX 590, VERONA, VA 24482-0590

(540) 245-5610 FAX (540) 245-5621

coadmin@co.augusta.va.us

November 27, 2018

Property Owner  
Middlebrook Community

RE: Internet Survey

Dear Property Owner:

Augusta County is applying for a Virginia Telecommunications Initiative 2019 grant for portions of the Middlebrook area. The project would include installation of fiber to the home. Your property may or may not be in the qualifying project area, however, your input is critical to beginning the process of extending service availability to unserved areas. Responses to the following questions will be included with public input for the grant:

Do you have internet service at your location?

Yes       No

If so, are you satisfied with your service?

Yes       No!

Who is your current internet provider?

Verizon

Thank you for taking the time to complete this short survey. Please return it in the enclosed envelope. If you are interested in completing the County's full Internet survey, go to [www.co.augusta.va.us](http://www.co.augusta.va.us) and see the survey under news and notices.

Sincerely,  
County of Augusta



**COUNTY OF AUGUSTA, VA.**

**BOARD OF SUPERVISORS**

MARSHALL W. PATTIE  
North River

GERALD W. GARBER  
Middle River

PAMELA L. CARTER  
Pastures

VACANT  
Beverley Manor

WENDELL L. COLEMAN  
Wayne

MICHAEL L. SHULL  
Riverheads

CAROLYN S. BRAGG  
South River



**TIMOTHY K. FITZGERALD – COUNTY ADMINISTRATOR**

**AUGUSTA COUNTY GOVERNMENT CENTER**

P.O. BOX 590, VERONA, VA 24482-0590

(540) 245-5610 FAX (540) 245-5621

coadmin@co.augusta.va.us

November 27, 2018

Property Owner  
Middlebrook Community

RE: Internet Survey

Dear Property Owner:

Augusta County is applying for a Virginia Telecommunications Initiative 2019 grant for portions of the Middlebrook area. The project would include installation of fiber to the home. Your property may or may not be in the qualifying project area, however, your input is critical to beginning the process of extending service availability to unserved areas. Responses to the following questions will be included with public input for the grant:

Do you have internet service at your location?  Yes  No

If so, are you satisfied with your service?  Yes  No

Who is your current internet provider? NOVEC

Thank you for taking the time to complete this short survey. Please return it in the enclosed envelope. If you are interested in completing the County's full Internet survey, go to [www.co.augusta.va.us](http://www.co.augusta.va.us) and see the survey under news and notices.

Sincerely,  
County of Augusta

**COUNTY OF AUGUSTA, VA.**

**BOARD OF SUPERVISORS**

MARSHALL W. PATTIE  
North River

GERALD W. GARBER  
Middle River

PAMELA L. CARTER  
Pastures

VACANT  
Beverley Manor

WENDELL L. COLEMAN  
Wayne

MICHAEL L. SHULL  
Riverheads

CAROLYN S. BRAGG  
South River



**TIMOTHY K. FITZGERALD – COUNTY ADMINISTRATOR**

**AUGUSTA COUNTY GOVERNMENT CENTER**

P.O. BOX 590, VERONA, VA 24482-0590

(540) 245-5610 FAX (540) 245-5621

coadmin@co.augusta.va.us

November 27, 2018

Property Owner  
Middlebrook Community

RE: Internet Survey

Dear Property Owner:

Augusta County is applying for a Virginia Telecommunications Initiative 2019 grant for portions of the Middlebrook area. The project would include installation of fiber to the home. Your property may or may not be in the qualifying project area, however, your input is critical to beginning the process of extending service availability to unserved areas. Responses to the following questions will be included with public input for the grant:

Do you have internet service at your location?  Yes  No

If so, are you satisfied with your service? Yes  No

Who is your current internet provider? Verizon

Thank you for taking the time to complete this short survey. Please return it in the enclosed envelope. If you are interested in completing the County's full Internet survey, go to [www.co.augusta.va.us](http://www.co.augusta.va.us) and see the survey under news and notices.

Sincerely,  
County of Augusta

COUNTY OF AUGUSTA, VA.

BOARD OF SUPERVISORS

MARSHALL W. PATTIE  
North River

GERALD W. GARBER  
Middle River

PAMELA L. CARTER  
Pastures

WENDELL L. COLEMAN  
Wayne

VACANT  
Beverley Manor

MICHAEL L. SHULL  
Riverheads

CAROLYN S. BRAGG  
South River



TIMOTHY K. FITZGERALD – COUNTY ADMINISTRATOR

AUGUSTA COUNTY GOVERNMENT CENTER

P.O. BOX 590, VERONA, VA 24482-0590

(540) 245-5610 FAX (540) 245-5621

coadmin@co.augusta.va.us

November 27, 2018

Property Owner  
Middlebrook Community

RE: Internet Survey

Dear Property Owner:

Augusta County is applying for a Virginia Telecommunications Initiative 2019 grant for portions of the Middlebrook area. The project would include installation of fiber to the home. Your property may or may not be in the qualifying project area, however, your input is critical to beginning the process of extending service availability to unserved areas. Responses to the following questions will be included with public input for the grant:

Do you have internet service at your location?

Yes  No

If so, are you satisfied with your service?

Yes  No

Who is your current internet provider?

VIASAT & Verizon MIFI

Thank you for taking the time to complete this short survey. Please return it in the enclosed envelope. If you are interested in completing the County's full Internet survey, go to [www.co.augusta.va.us](http://www.co.augusta.va.us) and see the survey under news and notices.

Sincerely,  
County of Augusta

**COUNTY OF AUGUSTA, VA.**

**BOARD OF SUPERVISORS**

MARSHALL W. PATTIE  
North River

GERALD W. GARBER  
Middle River

PAMELA L. CARTER  
Pastures

VACANT  
Beverley Manor

WENDELL L. COLEMAN  
Wayne

MICHAEL L. SHULL  
Riverheads

CAROLYN S. BRAGG  
South River



**TIMOTHY K. FITZGERALD – COUNTY ADMINISTRATOR**

**AUGUSTA COUNTY GOVERNMENT CENTER**

P.O. BOX 590, VERONA, VA 24482-0590

(540) 245-5610 FAX (540) 245-5621

coadmin@co.augusta.va.us

November 27, 2018

Property Owner  
Middlebrook Community

RE: Internet Survey

Dear Property Owner:

Augusta County is applying for a Virginia Telecommunications Initiative 2019 grant for portions of the Middlebrook area. The project would include installation of fiber to the home. Your property may or may not be in the qualifying project area, however, your input is critical to beginning the process of extending service availability to unserved areas. Responses to the following questions will be included with public input for the grant:

Do you have internet service at your location? Yes  No

If so, are you satisfied with your service? Yes  No

Who is your current internet provider? \_\_\_\_\_

Thank you for taking the time to complete this short survey. Please return it in the enclosed envelope. If you are interested in completing the County's full Internet survey, go to [www.co.augusta.va.us](http://www.co.augusta.va.us) and see the survey under news and notices.

Sincerely,  
County of Augusta

**COUNTY OF AUGUSTA, VA.**

**BOARD OF SUPERVISORS**

MARSHALL W. PATTIE  
North River

GERALD W. GARBER  
Middle River

PAMELA L. CARTER  
Pastures

VACANT  
Beverley Manor

WENDELL L. COLEMAN  
Wayne

MICHAEL L. SHULL  
Riverheads

CAROLYN S. BRAGG  
South River



**TIMOTHY K. FITZGERALD – COUNTY ADMINISTRATOR**

**AUGUSTA COUNTY GOVERNMENT CENTER**

P.O. BOX 590, VERONA, VA 24482-0590

(540) 245-5610 FAX (540) 245-5621

coadmin@co.augusta.va.us

November 27, 2018

Property Owner  
Middlebrook Community

RE: Internet Survey

Dear Property Owner:

Augusta County is applying for a Virginia Telecommunications Initiative 2019 grant for portions of the Middlebrook area. The project would include installation of fiber to the home. Your property may or may not be in the qualifying project area, however, your input is critical to beginning the process of extending service availability to unserved areas. Responses to the following questions will be included with public input for the grant:

Do you have internet service at your location?  Yes  No

If so, are you satisfied with your service?  Yes  No

Who is your current internet provider? mgw

Thank you for taking the time to complete this short survey. Please return it in the enclosed envelope. If you are interested in completing the County's full Internet survey, go to [www.co.augusta.va.us](http://www.co.augusta.va.us) and see the survey under news and notices.

Sincerely,  
County of Augusta

**COUNTY OF AUGUSTA, VA.**

**BOARD OF SUPERVISORS**

MARSHALL W. PATTIE  
North River

GERALD W. GARBER  
Middle River

PAMELA L. CARTER  
Pastures

VACANT  
Beverley Manor

WENDELL L. COLEMAN  
Wayne

MICHAEL L. SHULL  
Riverheads

CAROLYN S. BRAGG  
South River



**TIMOTHY K. FITZGERALD – COUNTY ADMINISTRATOR**

**AUGUSTA COUNTY GOVERNMENT CENTER**

P.O. BOX 590, VERONA, VA 24482-0590

(540) 245-5610 FAX (540) 245-5621

coadmin@co.augusta.va.us

November 27, 2018

Property Owner  
Middlebrook Community

RE: Internet Survey

Dear Property Owner:

Augusta County is applying for a Virginia Telecommunications Initiative 2019 grant for portions of the Middlebrook area. The project would include installation of fiber to the home. Your property may or may not be in the qualifying project area, however, your input is critical to beginning the process of extending service availability to unserved areas. Responses to the following questions will be included with public input for the grant:

Do you have internet service at your location?

Yes  No

If so, are you satisfied with your service?

Yes  No

Who is your current internet provider?

Verizon Wireless

Thank you for taking the time to complete this short survey. Please return it in the enclosed envelope. If you are interested in completing the County's full Internet survey, go to [www.co.augusta.va.us](http://www.co.augusta.va.us) and see the survey under news and notices.

Sincerely,  
County of Augusta

COUNTY OF AUGUSTA, VA.

BOARD OF SUPERVISORS

MARSHALL W. PATTIE  
North River

GERALD W. GARBER  
Middle River



PAMELA L. CARTER  
Pastures

VACANT  
Beverley Manor

WENDELL L. COLEMAN  
Wayne

MICHAEL L. SHULL  
Riverheads

CAROLYN S. BRAGG  
South River

TIMOTHY K. FITZGERALD – COUNTY ADMINISTRATOR

AUGUSTA COUNTY GOVERNMENT CENTER

P.O. BOX 590, VERONA, VA 24482-0590

(540) 245-5610 FAX (540) 245-5621

coadmin@co.augusta.va.us

November 27, 2018

Property Owner  
Middlebrook Community

RE: Internet Survey

Dear Property Owner:

Augusta County is applying for a Virginia Telecommunications Initiative 2019 grant for portions of the Middlebrook area. The project would include installation of fiber to the home. Your property may or may not be in the qualifying project area, however, your input is critical to beginning the process of extending service availability to unserved areas. Responses to the following questions will be included with public input for the grant:

Do you have internet service at your location? Yes  No

If so, are you satisfied with your service? Yes  No

Who is your current internet provider? \_\_\_\_\_

*We sure would love it!*

Thank you for taking the time to complete this short survey. Please return it in the enclosed envelope. If you are interested in completing the County's full Internet survey, go to [www.co.augusta.va.us](http://www.co.augusta.va.us) and see the survey under news and notices.

Sincerely,  
County of Augusta

**COUNTY OF AUGUSTA, VA.**

**BOARD OF SUPERVISORS**

MARSHALL W. PATTIE  
North River

GERALD W. GARBER  
Middle River

PAMELA L. CARTER  
Pastures

WENDELL L. COLEMAN  
Wayne

VACANT  
Beverley Manor

MICHAEL L. SHULL  
Riverheads

CAROLYN S. BRAGG  
South River



**TIMOTHY K. FITZGERALD – COUNTY ADMINISTRATOR**

**AUGUSTA COUNTY GOVERNMENT CENTER**

P.O. BOX 590, VERONA, VA 24482-0590

(540) 245-5610 FAX (540) 245-5621

coadmin@co.augusta.va.us



November 27, 2018

Property Owner  
Middlebrook Community

RE: Internet Survey

Dear Property Owner:

Augusta County is applying for a Virginia Telecommunications Initiative 2019 grant for portions of the Middlebrook area. The project would include installation of fiber to the home. Your property may or may not be in the qualifying project area, however, your input is critical to beginning the process of extending service availability to unserved areas. Responses to the following questions will be included with public input for the grant:

Do you have internet service at your location?

Yes

No



If so, are you satisfied with your service?

Yes

No

NA

Who is your current internet provider?



Thank you for taking the time to complete this short survey. Please return it in the enclosed envelope. If you are interested in completing the County's full Internet survey, go to [www.co.augusta.va.us](http://www.co.augusta.va.us) and see the survey under news and notices.

Sincerely,  
County of Augusta



**REQUEST FOR INFORMATION  
COUNTY OF AUGUSTA, VIRGINIA  
Virginia Telecommunications Initiative (VATI) Grant Opportunity  
RFI# 12010-19-1**

**Purpose:**

The County of Augusta is seeking one or more Internet Service Providers (ISPs) to partner with us to submit one or more applications for the 2019 Virginia Telecommunications Initiative (VATI) Grant opportunity. For more information on VATI, please review the [2019 Virginia Telecommunication Initiative Program Guidelines and Criteria](#) on the County's website at [www.co.augusta.va.us](http://www.co.augusta.va.us).

**Background:**

The Department of Housing and Community Development will award funding to eligible applicants to provide last-mile services to unserved areas of the State. The funds shall be used for providing financial assistance to supplement construction costs by private sector broadband service providers to extend service to areas that presently are defined as unserved per grant guidelines. The private sector broadband service provider (ISP) must have a 477 form filed with the FCC. Applicants must be in good standing in performance of any and all existing Commonwealth of Virginia contracts, and compliance with all federal, state and local laws. **The project must be shovel ready in order to comply with the construction deadline of May 16, 2020.**

**Requested Information:**

Through this RFI; eligible ISPs are encouraged to submit one or more VATI Broadband Project Proposals which could be included in Augusta County's application(s) for VATI funding. Each project proposal must contain information identified in the sections noted in Attachment A, as well as the 2019 VATI Program Guidelines and Criteria in order to comply with grant submission requirements.

**Desired Outcome:**

The desired outcome is a partnership with one or more ISPs to effectively submit applications for VATI funding. The County reserves the option to partner with more than one ISP in this VATI effort.

**Timeline:**

Responses to this RFI are **due by 2:00 p.m. on Tuesday, October 30, 2018**. One (1) original and two (2) copies will be required. Responses and all communications regarding this RFI should be submitted to:

Jennifer Whetzel, Deputy County Administrator  
County of Augusta  
18 Government Center Lane  
PO Box 590  
Verona, Virginia 24482

The Augusta Internet Initiative Committee will review responses and assess the ability to submit a grant application. ISPs should be aware that they will be involved in the grant writing process; fielding questions and providing data as needed by the County to ensure a complete application.

**Questions:**

Questions with regard to this RFI can be sent to the attention of:

Jennifer Whetzel, Deputy County Administrator

Email: [jwhetzel@co.augusta.va.us](mailto:jwhetzel@co.augusta.va.us)

**Disclaimer:**

Please be advised that this is a request for information only. This RFI does not constitute a request for proposal or a promise to issue an RFP in the future. This RFI is issued for the purposes of submittal of an application and potential approval of a VATI grant. This RFI and any responses to this RFI will be used in accordance with the 2019 VATI Program Guidelines and Criteria.

This RFI is neither a request nor a commitment by the County of Augusta, Virginia (the "County") to contract for any supply or service whatsoever. Furthermore, the County is not at this time seeking proposals and will not accept unsolicited proposals. Parties responding are advised that the County will not pay for any information or administrative costs incurred in response to this RFI; all costs associated with responding to this RFI will be solely at the interested party's expense.

## ATTACHMENT A

**(For a complete list of requirements, please review the Virginia Telecommunications Initiative (VATI) Grant 2019 Program Guidelines and Criteria on the County's website at [www.co.augusta.va.us](http://www.co.augusta.va.us) in its entirety.)**

### Project Area

1. Provide a map and description of the proposed geographic area including specific boundaries of the project area e.g.; street names, local and regional boundaries, etc. Explain why and how the project area(s) was selected. Attach a copy of your map(s).
2. Within the proposed project area, provide a map and list of all existing providers (fixed and wireless), estimate of customers serviced by these providers and speeds of service provided. Provide a detailed explanation of how this information was compiled and the source(s).

### Project Need/Description

3. Provide documentation that demonstrates that the proposed project area(s) is unserved. An unserved area is defined as an area with speeds of 10 Mbps/1 Mbps or less, and with less than 10% service overlap within the project area. Describe the anticipated service overlap with current providers within the project area.
4. Describe population both in terms of absolute numbers within the project area and the eligible users that will be served by the proposed project. Describe the basis for these projections.
5. Indicate the numbers of businesses and community anchor institutions the proposed project will pass in the project area.
6. Provide the anticipated take rate for the proposed service within one year of project completion and describe the basis for the estimate. Also provide all actions to be implemented to reach the identified potential customers within the project area.
7. A statement whether the proposed project is targeting the "last mile," "middle mile," or "backbone" portion of the broadband infrastructure.
8. For wireless projects only: Please explain the ownership of the proposed wireless infrastructure. Will the wireless ISP own or lease the radio mast, tower, or other raised structure onto which the wireless infrastructure will be installed?
9. Provide a description of the broadband service to be provided, including

estimated download and upload speeds, whether that speed is based on dedicated or shared bandwidth, and the technology that will be used. This description can be illustrated by a map or schematic diagram, as appropriate.

10. Provide a description of the network system design used to deliver broadband service from the network's primary Internet point(s) of presence to end users, including the network components that already exist and the ones that would be added by the proposed project. Also describe specific advantages of using this technology. Provide a detailed explanation on how this information was compiled and source(s). For wireless projects, provide a propagation map including the proposed project.

### Project Readiness

11. Describe the current state of project development (i.e. planning, preliminary engineering, final design, etc.)?
12. Prepare a detailed project timeline or construction schedule, which identifies specific tasks, staff, contractor responsible(s), collection of data, etc., and estimated start and completion dates. The timeline should include all activities being completed within 12 months of contract execution with DHCD (or no later than May 16, 2020).
13. Provide a description of the matching funds the ISP and County will need to invest in the proposed project, (VATI funding cannot exceed 80% of total project cost).
14. The County as applicant will assist the ISP as co-applicant with a description of the public-private partnership involved in the project.
15. Identify key individuals, including name and title, who will be responsible for the management of the project. Describe their role and responsibilities for the project.

### Project Budget and Cost Appropriateness

16. Provide a detailed budget as to how the grant funds will be utilized, including an itemization of equipment and construction costs and a justification of proposed expenses. Expenses should be substantiated by clear cost estimates.
17. A description of ISP's history or experience with managing grants and constructing broadband communications facilities in the Commonwealth of Virginia and elsewhere.

## Service Provision

18. Describe the Internet service offerings to be provided after completion of this project and your price structure for these services. The service offerings should include all relevant tiers.

## Additional Information

19. Any other equitable factor that the ISP desires to include.

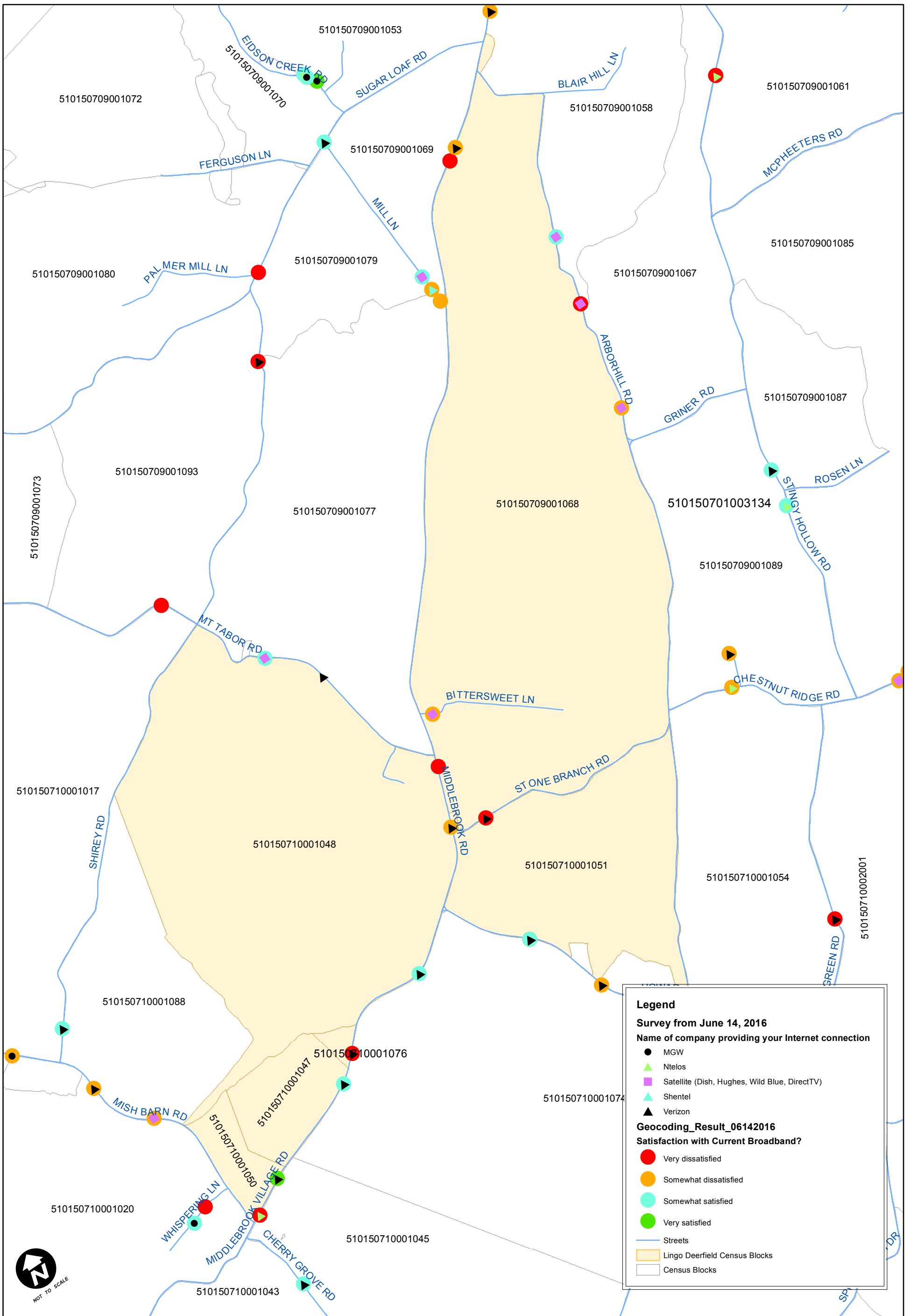

# Middlebrook Outreach Effort



## FCC Form 477 Data for Middlebrook Project Area

ProviderName	DBAName	CensusBlock	TechCode	MaxAdDown	MaxAdUp
MGW Networks, L.L.C.	MGW Networks	510150709001059	70	6	1
Rural Broadband Network Services LLC	HighSpeedLink.net	510150709001059	70	12	3
UNITED STATES CELLULAR CORPORATION	United States Cellular Corporation	510150709001059	70	1	0.2
MGW Networks, L.L.C.	MGW Networks	510150709001068	70	6	1
Verizon Virginia LLC	Verizon Virginia LLC	510150709001068	10	5	0.768
Rural Broadband Network Services LLC	HighSpeedLink.net	510150709001068	70	12	3
UNITED STATES CELLULAR CORPORATION	United States Cellular Corporation	510150709001068	70	1	0.2
King Street Wireless, L.P.	King Street Wireless L.P.	510150709001068	70	1	0.2
COMCAST CABLE COMMUNICATIONS, LLC	Comcast	510150709001068	42	0	0
MGW Networks, L.L.C.	MGW Networks	510150709001090	70	6	1
Rural Broadband Network Services LLC	HighSpeedLink.net	510150709001090	70	12	3
UNITED STATES CELLULAR CORPORATION	United States Cellular Corporation	510150709001090	70	1	0.2
King Street Wireless, L.P.	King Street Wireless L.P.	510150709001090	70	1	0.2
Rural Broadband Network Services LLC	HighSpeedLink.net	510150710001047	70	12	3
MGW Networks, L.L.C.	MGW Networks	510150710001047	70	6	1
King Street Wireless, L.P.	King Street Wireless L.P.	510150710001047	70	1	0.2
MGW Networks, L.L.C.	MGW Networks	510150710001048	70	6	1
Verizon Virginia LLC	Verizon Virginia LLC	510150710001048	10	5	0.768
Rural Broadband Network Services LLC	HighSpeedLink.net	510150710001048	70	12	3
UNITED STATES CELLULAR CORPORATION	United States Cellular Corporation	510150710001048	70	1	0.2
King Street Wireless, L.P.	King Street Wireless L.P.	510150710001048	70	1	0.2
COMCAST CABLE COMMUNICATIONS, LLC	Comcast	510150710001048	43	0	0
Rural Broadband Network Services LLC	HighSpeedLink.net	510150710001050	70	12	3
MGW Networks, L.L.C.	MGW Networks	510150710001050	70	6	1
King Street Wireless, L.P.	King Street Wireless L.P.	510150710001050	70	1	0.2
MGW Networks, L.L.C.	MGW Networks	510150710001051	70	6	1
Rural Broadband Network Services LLC	HighSpeedLink.net	510150710001051	70	12	3
Verizon Virginia LLC	Verizon Virginia LLC	510150710001051	10	5	0.768
UNITED STATES CELLULAR CORPORATION	United States Cellular Corporation	510150710001051	70	1	0.2
King Street Wireless, L.P.	King Street Wireless L.P.	510150710001051	70	1	0.2
Rural Broadband Network Services LLC	HighSpeedLink.net	510150710001076	70	12	3
MGW Networks, L.L.C.	MGW Networks	510150710001076	70	6	1

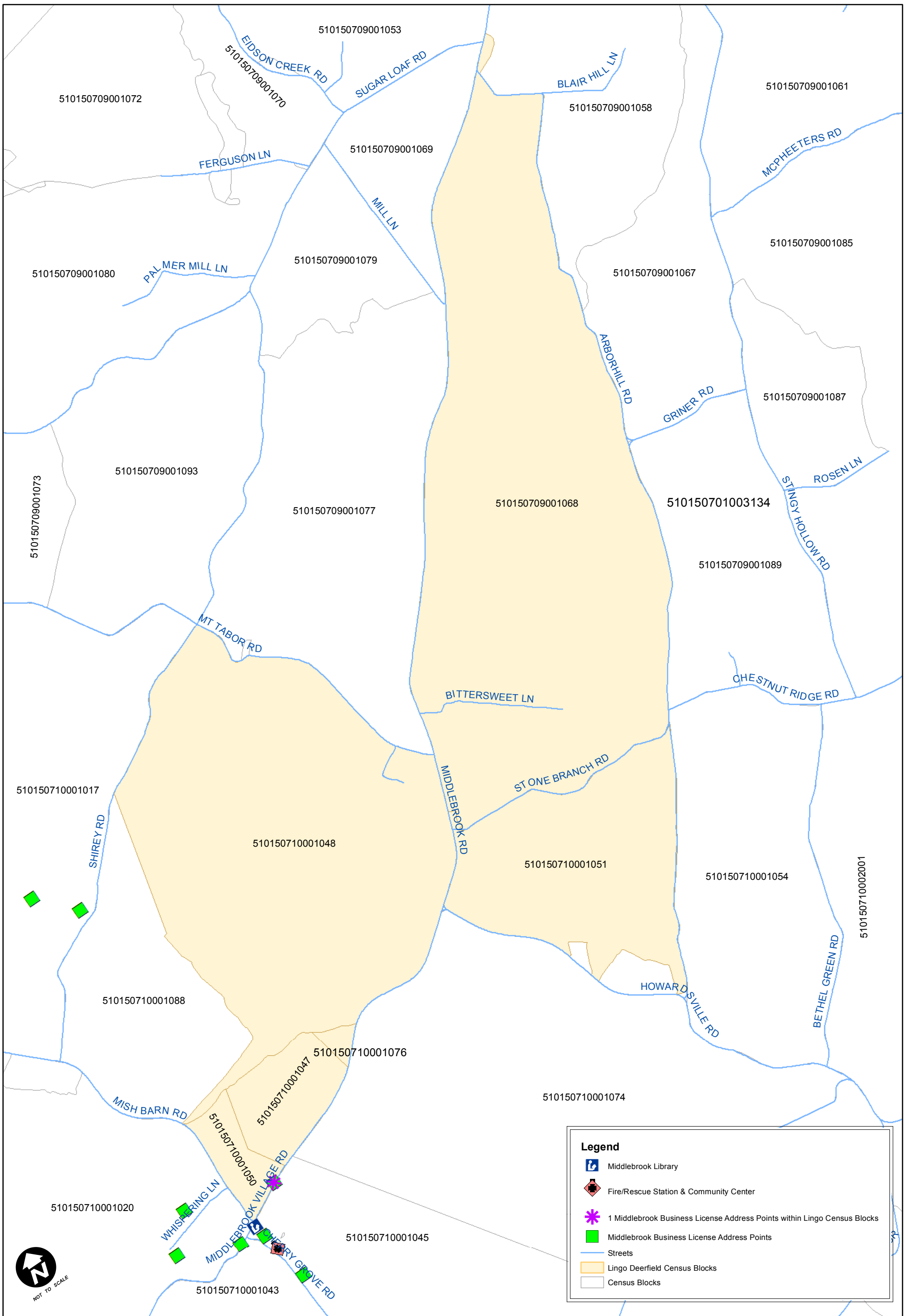

# Middlebrook Businesses and Anchor Institutions







# NETWORK DIAGRAM

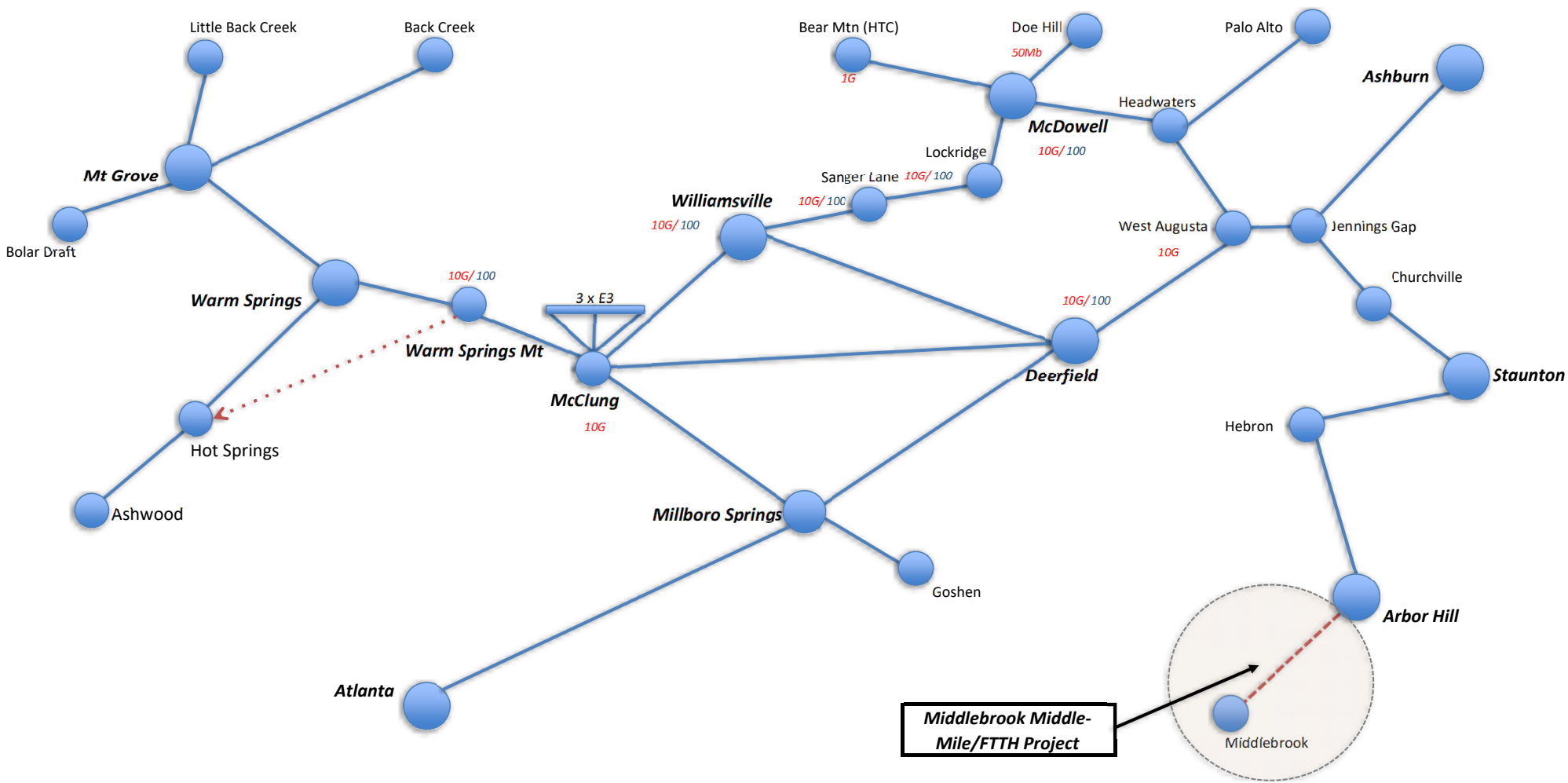

# Fiber Network Architecture

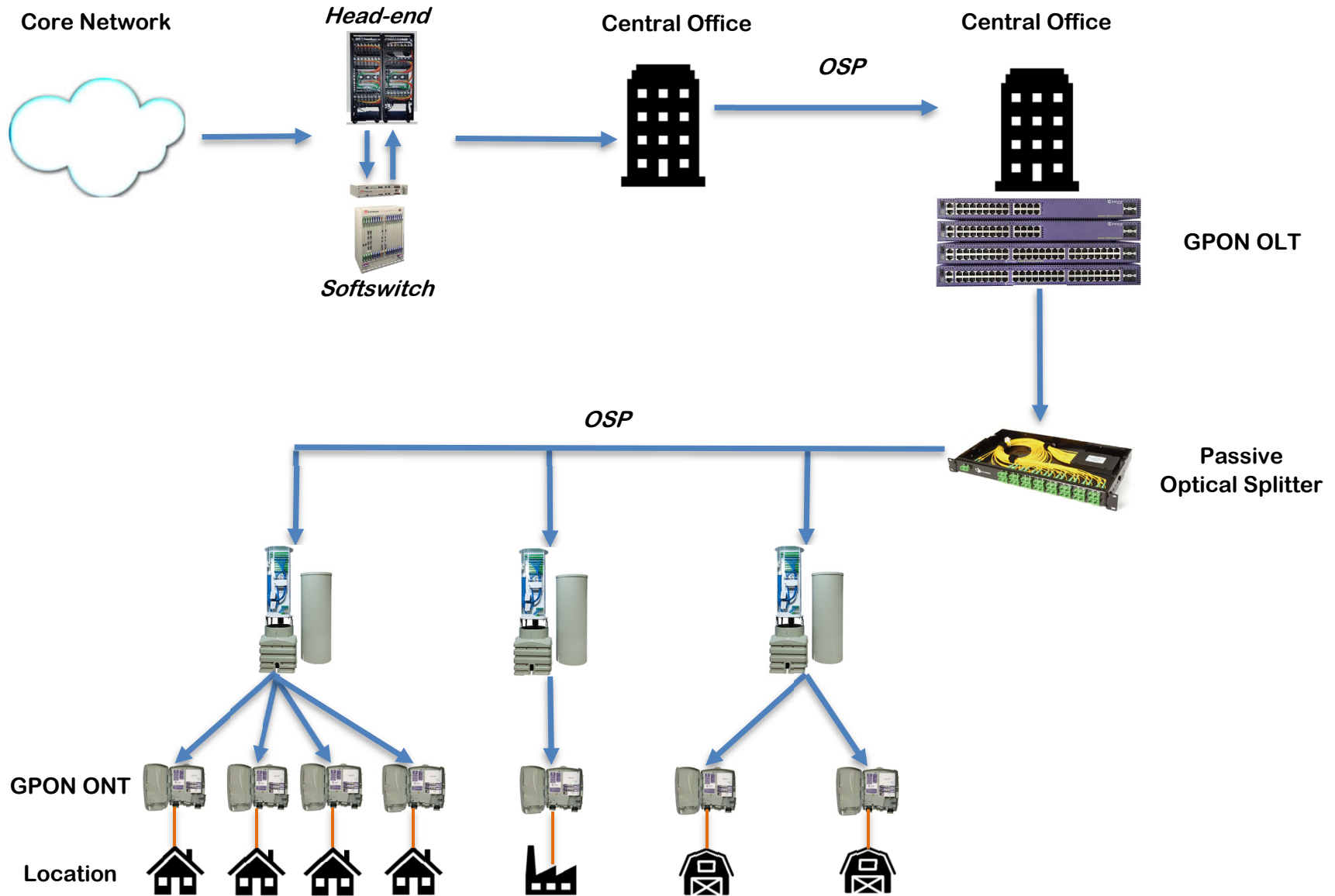

## VATI 2019 Application - Augusta County - Middlebrook Fiber Project

<b>Key Individuals Assigned to Project</b>		
<u>Name</u>	<u>Title</u>	<u>Responsibilities</u>
Craig Smith	President, MGW/Lingo Networks	Community and County liaison; Oversee startup, implementation and construction of the project, transition to final service products
Tony McCune	Network Operation Manager, MGW/Lingo Networks	Oversee installation of fiber and electronic equipment
Ryan Smith	Vice President, MGW/Lingo Networks	Manage customer service during transition and after
Robert Huff	Director of Strategic Planning, MGW/Lingo Networks	Planning and grant management
Jennifer Whetzel	Deputy County Administrator, Augusta County	Draft, submit grant application; Grant management if awarded
Jackie Zetwick	IT Director, Augusta County	Assist with project oversight for County interests